



FLOS

Decorative Catalog 2013



FLOSUSA.COM

IT ALL STARTED WITH COCOON...

Flos was founded in 1962 in Merano, Italy with the aim to develop a line of new lighting concepts utilizing a material called the cocoon, a spray-on plastic coating made in the United States, and a novelty in Italy at the time. The company enlisted the support of Achille and Pier Giacomo Castiglioni and Tobia Scarpa, who successfully produced a line of lighting products that are still in production today.

In 1964 Sergio Gandini joined the company, and the company headquarters was moved to a new site near Brescia, Italy. The first Flos retail store, designed by the Castiglioni brothers opened in Milan in 1968.

From the very outset, the distinguishing feature of the company has been its approach to lamp design and production in the highest quality. Flos has always worked with well-known and established designers starting with the Castiglioni brothers and Tobia Scarpa, who were followed by Philippe Starck, Konstantin Grcic, Jasper Morrison, Marc Newson, Antonio Citterio, Ron Gilad, Patricia Urquiola, Marcel Wanders, to name a few. Collaborations with this international roster of talents have resulted in some of the best-known and commercially successful products in industrial design. It has also resulted in numerous awards and accolades for both the designers and the company. Flos products are also included in many permanent collections of design and art museums around the world.

Since 1996 Flos is led by Sergio's son, Piero, and the company has grown into an international organization that offers a complete range of residential, commercial and even custom-made lighting products. The company's contract division assists architects with the know-how it has acquired over forty years of experience not only as a manufacturer, but also as a specialty lighting systems designer for a wide-range of environments. With its tireless pursuit of innovation and cutting-edge technology, Flos has firmly established itself as a global leader in lighting design.

Flos remains true to its origins as a company and strives to consistently uphold the following "Flosophy":

- Be THE solution to all lighting needs
- Retain identity as a true "Italian Design Factory"
- Work with the best designers
- Invest in researching innovative materials and technology
- Create products with iconic and symbolic appeal

Flos is also a company fully committed to environmental issues, constantly developing products that are least harmful to the environment both in terms of material and in the production methods it employs.





E. BARBER & J. OSGERBY



MARCELLO ZILIANI



R. & E. BOUROULLEC



TOBIA SCARPA



JOHANNA GRAWUNDER



SEBASTIAN WRONG



JORIS LAARMAN

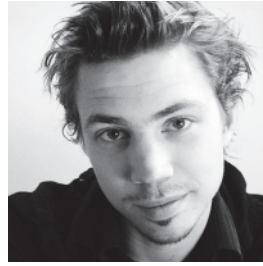

RON GILAD

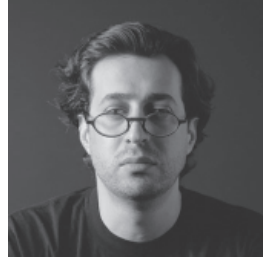

PATRICIA URQUIOLA



RODOLFO DORDONI



MARCEL WANDERS



KONSTANTIN GRČIČ



ANTONIO CITTERIO



PHILIPPE STARCK



ACHILLE AND
PIER GIACOMO CASTIGLIONI



MARC NEWSON



PAOLO RIZZATTO



GINO SARFATTI



PIERO LISSONI



JASPER MORRISON

























ALPHABETIC INDEX BY TYPE

TABLE

6

	AOY	086
	ARÀ	068
	ARCHIMON K	050
	ARCHIMON SOFT	052
	BIAGIO	090
	D'E-light	020
	GATTO	089
	GIBIGIANA	092
	MINI GLO-BALL T	074
	GLO-BALL BASIC ZERO	076
	GLO-BALL BASIC	078

	GLO-BALL T	080		MISS SISSI	095
	GOLDMAN	016		PIANI	032
	GUNS BEDSIDE GUN	065		RAY T	056
	GUNS TABLE GUN	064		ROMEO MOON T	082
	MINIKELVIN LED	044		ROMEO SOFT T	084
	KELVIN LED	036		SNOOPY	088
	KTRIBE T	058		SPUN LIGHT T	072
	KTRIBE T1 GLASS	062		TAB T	048
	LAMPADINA	094		TACCIA TACCIA LED	066
	MAY DAY	096		TATOU T1	026
	MINI TECA	054			
	MISS K	070			

FLOOR

	ARCO	100
	ARCO LED	101

	BIBLIOTHEQUE NATIONALE	102		ROSY ANGELIS	139		CHASEN	180
	BRERA F	138		SPUN LIGHT F	126		CICATRICES DE LUXE 3	212
	CHRYSALIS	110		STYLOS	140		CICATRICES DE LUXE 5	214
	FANTASMA	136		SUPERARCHIMOOON	134		CICATRICES DE LUXE 8	215
	GLO-BALL F	128		TAB F	116		FRISBI	218
	GUNS LOUNGE GUN	142		TATOU F	106		FUCSIA 1	200
	KELVIN LED F	114		TOIO	120		FUCSIA 3	202
	KTRIBE F2	122	PENDANT				FUCSIA 8	204
	KTRIBE F3	124		2097/30 2097/50	226		FUCSIA 12	203
	RAY F	118		AIM	148		GLO-BALL S	206
	ROMEO MOON F	130		BRERA S	216		KTRIBE S	194
	ROMEO SOFT F	132		CAN CAN	164		LASTRA 6	209

ALPHABETIC INDEX BY TYPE

8

	LAISTRA 8 RECTANGULAR	208		TARAXACUM 2	191		MINI GLO-BALL C/W	270
	LONG & HARD	184		TARAXACUM 88 S1	228		GLO-BALL C/W ZERO	271
	NEBULA	172		TATOU S	160		GLO-BALL C	272
	PARENTESI	198		VISCONTEA	190		GLO-BALL W	274
	RAY S	192		ZEPPELIN	186		HIDE	236
	ROMEO LOUIS II	220	CEILING/WALL				LIGHTSPRING SINGLE & DOUBLE	252
	ROMEO MOON S	222		265	266		LONG LIGHT	250
	ROMEO SOFT S	224		ALL LIGHT	278		ONTHEROCKS HL	268
	SKYGARDEN	176		ARIETTE	276		OROTUND	232
	SMITHFIELD S	168		MINI BUTTON	265		POCHETTE	262
	SPLÜGEN BRÄU	219		CLESSIDRA	242		SKYGARDEN RECESSED	258
	TARAXACUM 1	191		FOGLIO	260		SMITHFIELD C	256



TAU 254



TIGHT LIGHT 248



TILEE 264

OUTDOOR



45 292



ALL LIGHT 320



BELVEDERE CLOVE 284



BELVEDERE ROUND 286



BELVEDERE SPOT F1 288



BELVEDERE SPOT F2 288



BELVEDERE SPOT F3 288



BOX MINI BOX 318



CLESSIDRA 304



GIANO 310



G-O 308



KTRIBE F3 OUTDOOR 298



MINI BUTTON 316



ROMEO OUTDOOR 300



SUPERARCHIMOON OUTDOOR 296



THEBLOCKOFLIGHT 306



WALLFLOWER 312

COMBINATIONS

10



PAGE 052



PAGE 058



PAGE 084



PAGE 084



PAGE 132



PAGE 134



PAGE 138



PAGE 138



PAGE 138



PAGE 216



PAGE 056



PAGE 118



PAGE 050



PAGE 070



PAGE 058



PAGE 062



PAGE 058



PAGE 224

PAGE 224



PAGE 082



PAGE 082



PAGE 130



PAGE 222



PAGE 222



PAGE 118



PAGE 192



PAGE 176



PAGE 176



PAGE 258



PAGE 122



PAGE 124



PAGE 194



PAGE 194



PAGE 194



PAGE 026



PAGE 106



PAGE 160



PAGE 160

COMBINATIONS

12



PAGE 076



PAGE 078



PAGE 078



PAGE 080



PAGE 080



PAGE 128



PAGE 128



PAGE 128



PAGE 089



PAGE 089



PAGE 136



PAGE 136



PAGE 191



PAGE 191



PAGE 065



PAGE 064



PAGE 142

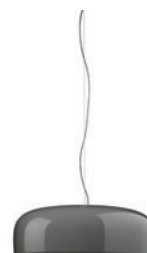

PAGE 168



PAGE 256



PAGE 206

PAGE 206

PAGE 271

PAGE 272

PAGE 272

PAGE 274

PAGE 074

PAGE 270

13



PAGE 190

PAGE 186

PAGE 186



PAGE 072



PAGE 072



PAGE 126



PAGE 048



PAGE 116

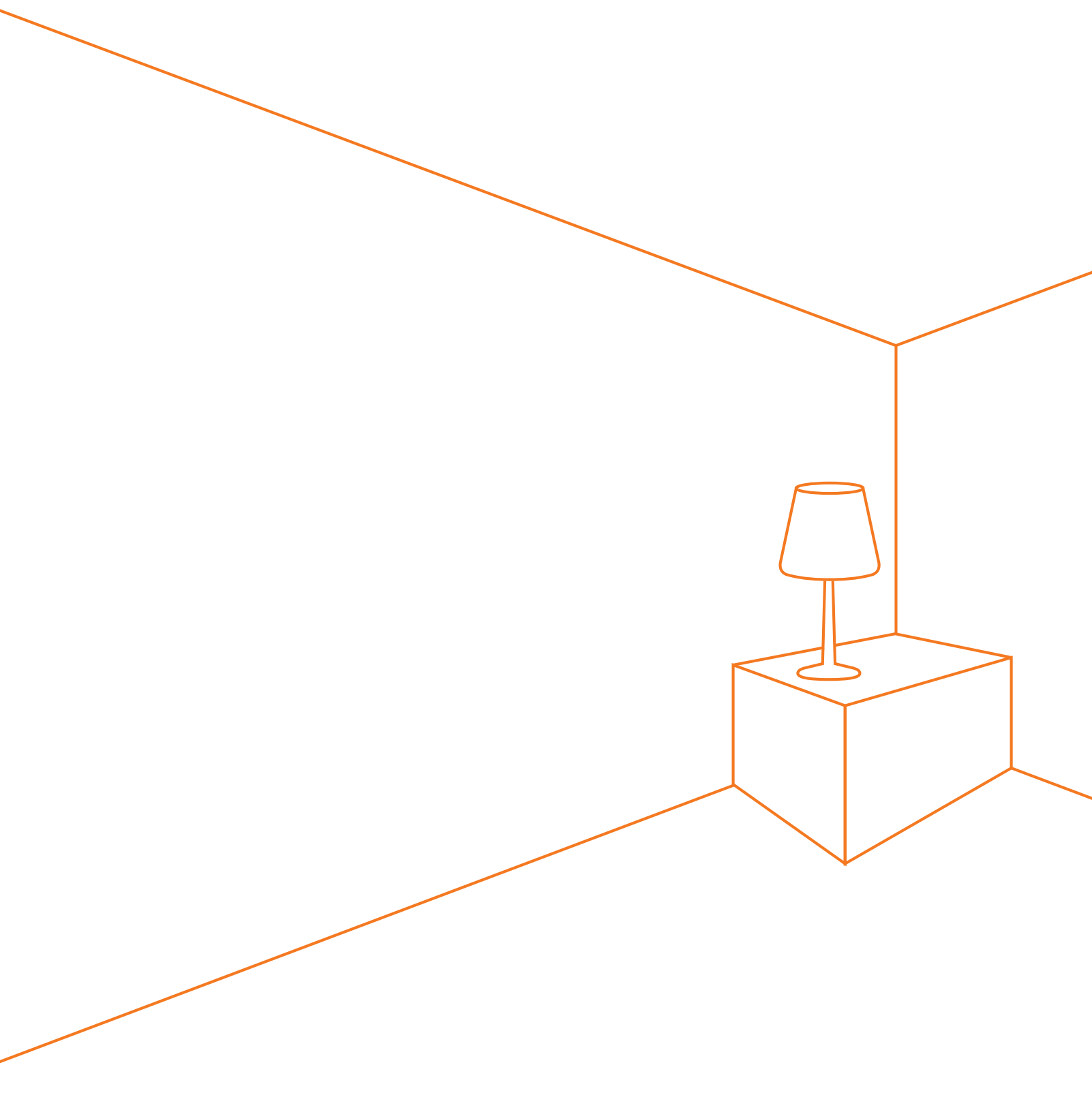

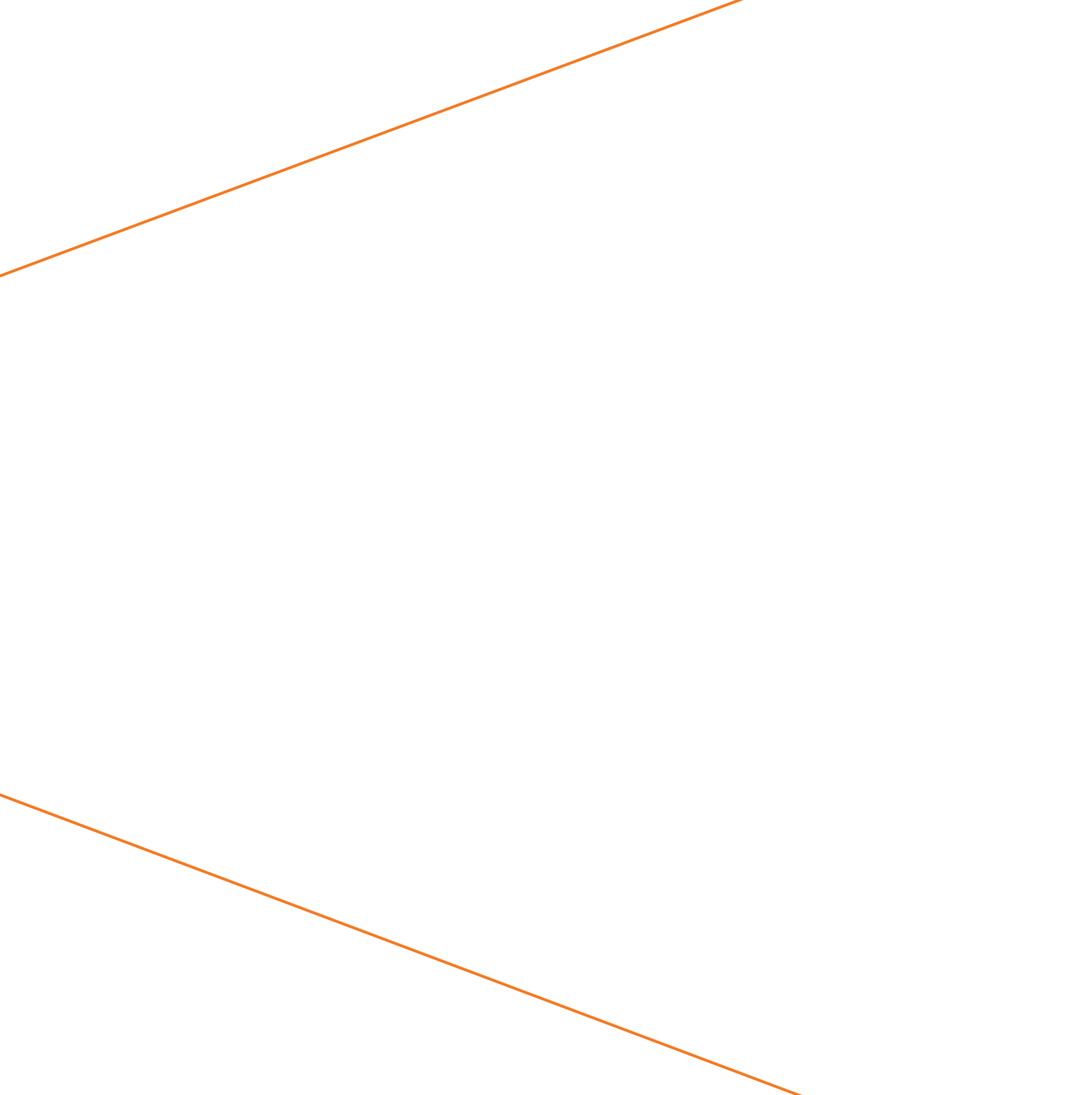







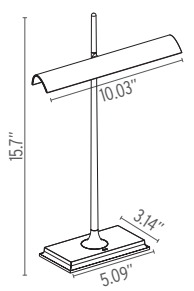

GOLDMAN	
DESIGN RON GILAD 2013	
LAMP: 42 LED 5W - 2700K - 420LM TOTAL - CRI85	2 (lbs.)
<input checked="" type="radio"/> F3140044 <input type="radio"/> F3140030	
CONSTRUCTION MATERIALS: ALUMINUM, POLYCARBONATE, METACRYLATE	CERTIFICATIONS:



"Made for iPod," "Made for iPhone," and "Made for iPad" mean that an electronic accessory has been designed to connect specifically to iPod, iPhone, or iPad, respectively, and has been certified by the developer to meet Apple performance standards. Apple is not responsible for the operation of this device or its compliance with safety and regulatory standards. Please note that the use of this accessory with iPod, iPhone, or iPad may affect wireless performance.

Made for



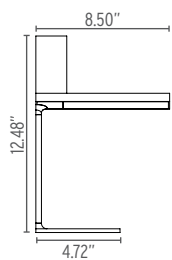

D'E-light

DESIGN **PHILIPPE STARCK 2011**

LAMP: FLAT PANEL 2700K 299lm CRI 85 - 5W
CHARGER 30PIN/8PIN/MICRO USB

2.2 (lbs.)

● F0030057 (30PIN) ● F0028057 (8PIN) ● F0029057 (MICRO USB)

CONSTRUCTION MATERIALS:
ALUMINUM AND ZAMAK



CHARGER 30 PIN

Compatibility: iPhone 3G / iPhone 3GS / iPhone 4 / iPhone 4S / iPad (1th generation) / iPad 2 (2nd generation) / iPad (3rd generation) / iPod 5th Generation (video) / iPod classic 80GB/160GB (2007) / iPod classic 120GB (2008) / iPod classic 160GB (2009) / iPod nano 1th Generation / iPod nano 2nd Generation / iPod nano 3rd Generation (video) / iPod nano 4th Generation (video) / iPod nano 5th Generation (video camera) / iPod nano 6th Generation / iPod touch 1st Generation / iPod touch 2nd Generation / iPod touch 3rd Generation / iPod touch 4th Generation



"Made for iPod," "Made for iPhone," and "Made for iPad" mean that an electronic accessory has been designed to connect specifically to iPod, iPhone, or iPad, respectively, and has been certified by the developer to meet Apple performance standards. Apple is not responsible for the operation of this device or its compliance with safety and regulatory standards. Please note that the use of this accessory with iPod, iPhone, or iPad may affect wireless performance.

Made for





LIGHTNING CHARGER 8 PIN
Compatibility: iPhone 5 / iPad (4th generation) / iPad mini /
iPod nano 7th Generation / iPod touch 5th Generation 32GB/64GB

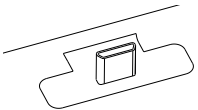

MICRO USB CHARGER

Please verify micro USB interface position and orientation on your device



TATOU T1

DESIGN PATRICIA URQUIOLA 2012

LAMP: 1 X MAX 75W E26 TYPE T

5,95 (lbs.)

● FU776109 ● FU776130 ● FU776148

CONSTRUCTION MATERIALS:
POLYCARBONATE, STEEL

CERTIFICATIONS:

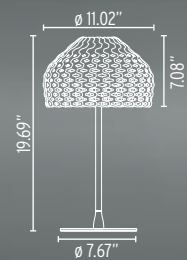



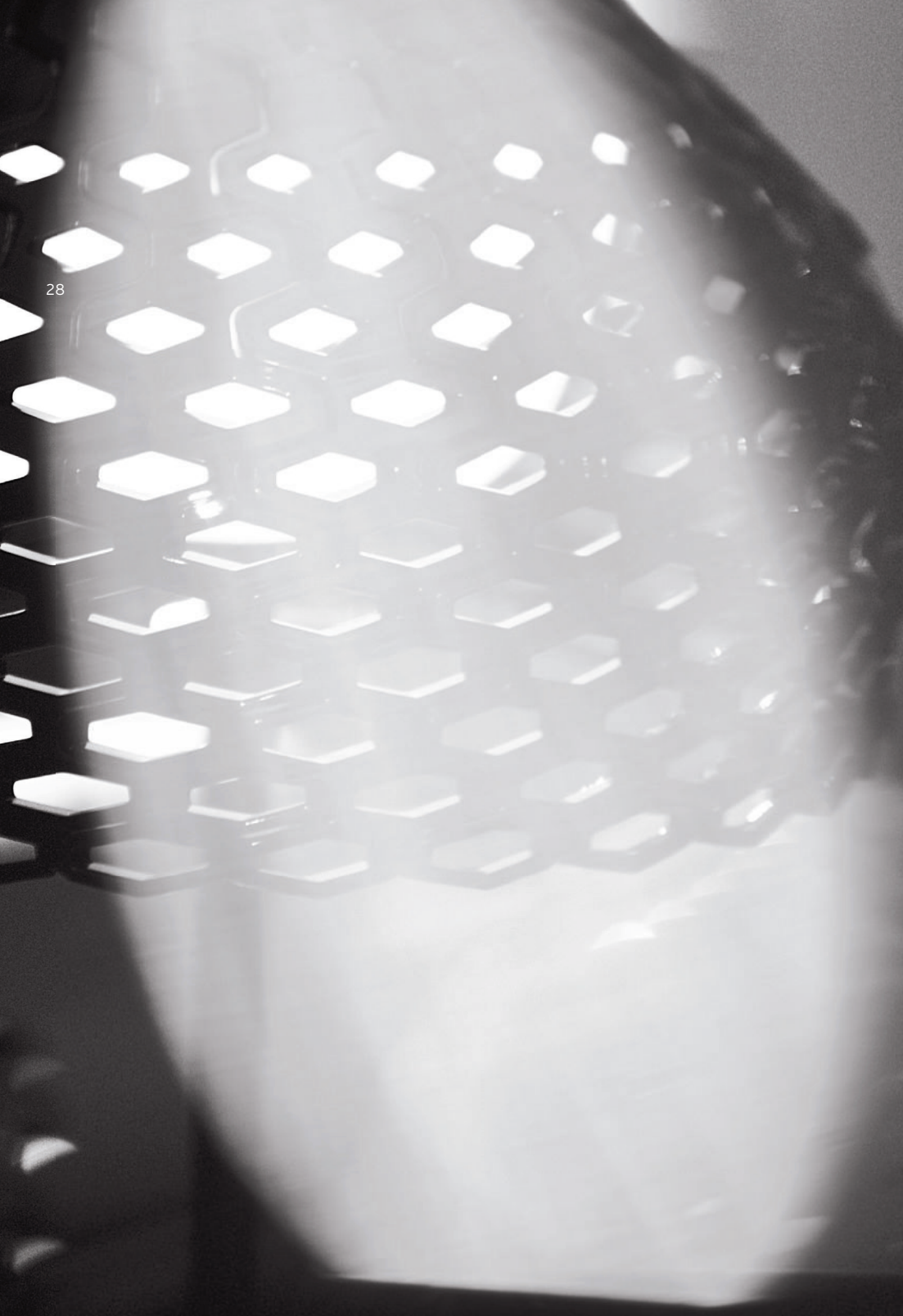











PIANI

DESIGN R. & E. BOURULLEC 2011

LAMP: 14 X TOP LED 2700K 336lm total CRI 90 - 5W

3.75 (lbs.)



F5830009



F5830030



F5830035



F5830039

CONSTRUCTION MATERIALS:
ABS, ALUMINUM, PMMA



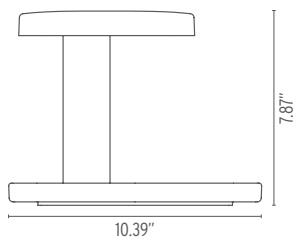

Turn into
Green Mode
and let your
Kelvin LED
compensate
ambience light
to save even
more energy.









KELVIN LED

DESIGN ANTONIO CITTERIO WITH TOAN NGUYEN 2009

BASE GREEN MODE I	● F3311030	○ F3311009	● F3311033	▯ F3311057	9,7 (lbs.)
BASE GREEN MODE II	● F3395030	○ F3395009	● F3395033	▯ F3395057	9,7 (lbs.)
CLAMP	● F3301030	○ F3301009	● F3301033	▯ F3313057	9,8 (lbs.)
WALL ARM	● F3302030	○ F3302009	● F3302033	▯ F3314057	9,9 (lbs.)
DESK SUPPORT with visible cable	● F3308030	○ F3308009	● F3308033	▯ F3308057	10,1 (lbs.)
DESK SUPPORT with hidden cable	● F3309030	○ F3309009	● F3309033	▯ F3309057	10,2 (lbs.)
LAMPS: 30 TOP LED 3000K 325LM TOTAL - CRI 95 - 7,5W - GREEN MODE					CERTIFICATIONS: cUL UL
CONSTRUCTION MATERIALS: ALUMINUM					





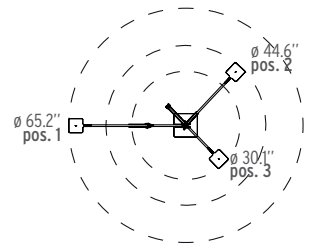
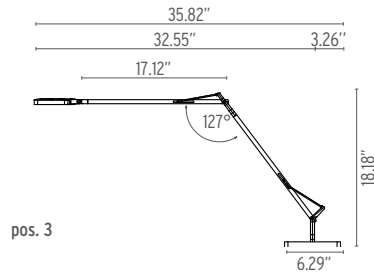
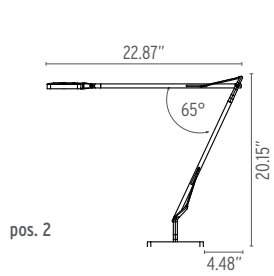
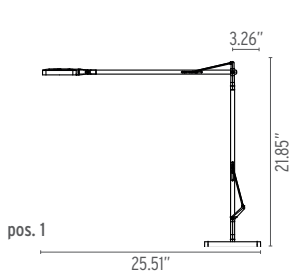



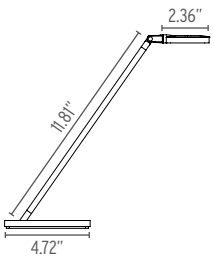

**MINIKELVIN LED**DESIGN **ANTONIO CITTERIO 2011****LAMP:** 36 x TOP LED 3000K 216lm total - CRI 80 - 4W (DIMMING)

1.76 (lbs.)

 F4180057**CONSTRUCTION MATERIALS:**
ALUMINUM**CERTIFICATIONS:**







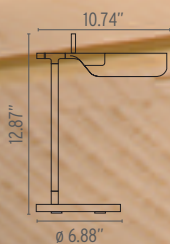

TAB T

DESIGN E. BARBER & J. OSGERBY 2011

● F6560009 ● F6560030

1,8 (lbs.)

LAMP: 14 LED 3000K 425lm CRI 80 - 5W

CERTIFICATIONS:

CONSTRUCTION MATERIALS: ALUMINUM, PMMA





ARCHIMOON K

DESIGN PHILIPPE STARCK 2004

LAMPS: 1 X 40W T4 G9 FROSTED

11,68 (lbs.)

● FU036800B

CONSTRUCTION MATERIALS:
POLYCARBONATE, GLASS, ALUMINUM

CERTIFICATIONS:

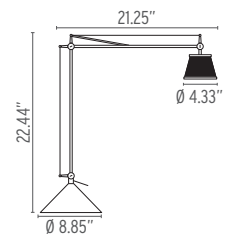

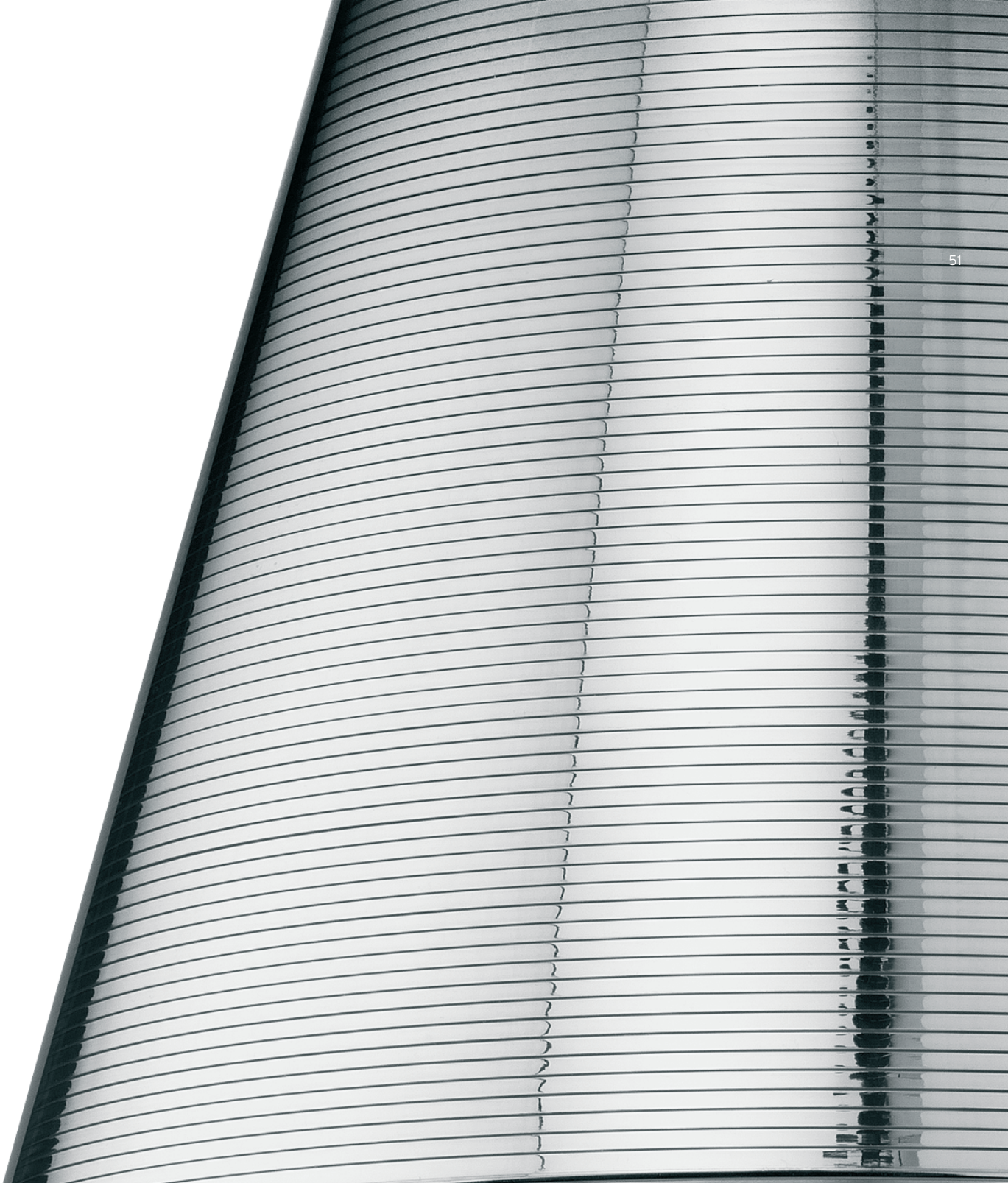

ARCHIMON SOFT

DESIGN PHILIPPE STARCK 1998

LAMPS: 1 X 40W T4 G9 FROSTED

12,12 (lbs.)

● FU037300AB

CONSTRUCTION MATERIALS:
ALUMINUM, GLASS, FABRIC

CERTIFICATIONS:

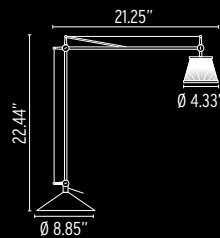





VICTORIAN GRANDEUR

MINI TECA

DESIGN RON GILAD 2009

RENAISSANCE CUPOLA	 FU991200	7.48 (lbs.)
VICTORIAN GRANDEUR	 FU991100	7.48 (lbs.)

LAMP: 1 X 25W T4 G9

CONSTRUCTION MATERIALS:
ABS, FABRIC, METHACRYLATE, STAINLESS STEEL

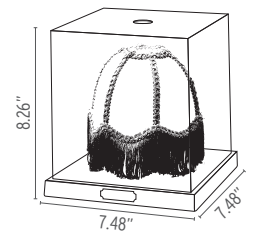



RENAISSANCE CUPOLA

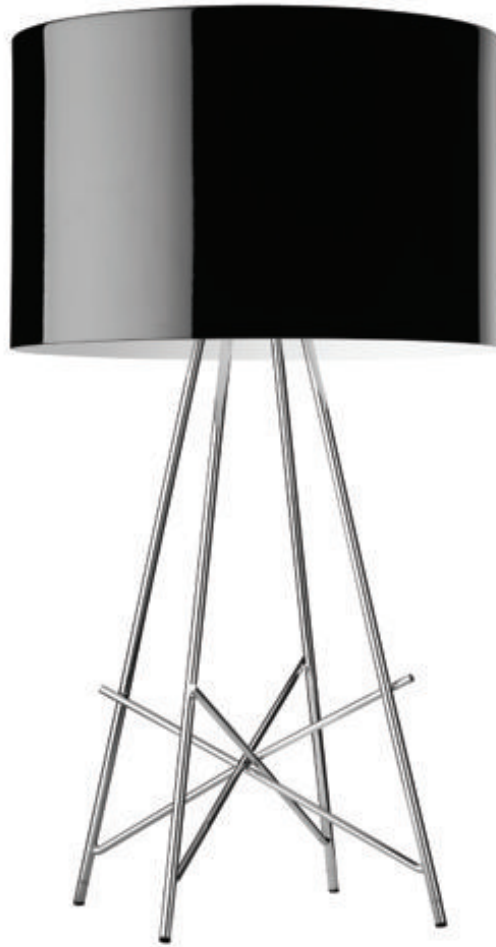

RAY T

DESIGN **RODOLFO DORDONI 2007**

LAMP: 1 x 150W T10 MEDIUM BASE

● FU591130 ○ FU591109 ● FU591020

CONSTRUCTION MATERIALS:
STEEL, ALUMINUM, GLASS

4,2 (lbs.) METAL
14,99 (lbs.) GLASS

CERTIFICATIONS:

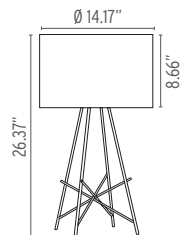





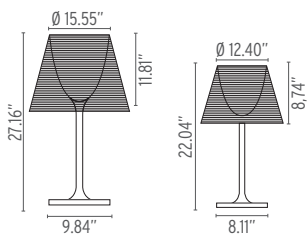

KTRIBE T

DESIGN PHILIPPE STARCK 2007

KTRIBE T1	LAMP: 1 X 72W BT15	6,83 (lbs.)
GRAY BODY: ● FU627500 ● FU627530 CHROME BODY: ● FU627800 ● FU627830		
KTRIBE T2	LAMP: 1 X 150W T10 MEDIUM BASE	13 (lbs.)
CHROME BODY: ● FU630300 ● FU630304 ● FU630330 ● FU630346 ● FU630307		

CONSTRUCTION MATERIALS:
ALUMINUM, METHACRYLATE, POLYCARBONATE (T1)
ALUMINUM, POLYCARBONATE, POLYMETHYLMETHACRYLATE, FABRIC (T2)

CERTIFICATIONS:









KTRIBE T1 GLASS

DESIGN PHILIPPE STARCK 2007

LAMP: 1 X 72W TYPE BT15

10,14 (lbs.)

GRAY BODY: ● FU628400 CHROME BODY: ● FU628100

CONSTRUCTION MATERIALS:
ALUMINUM, GLASS, POLYCARBONATE

CERTIFICATIONS:

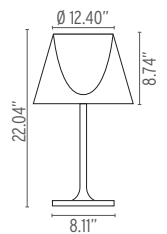

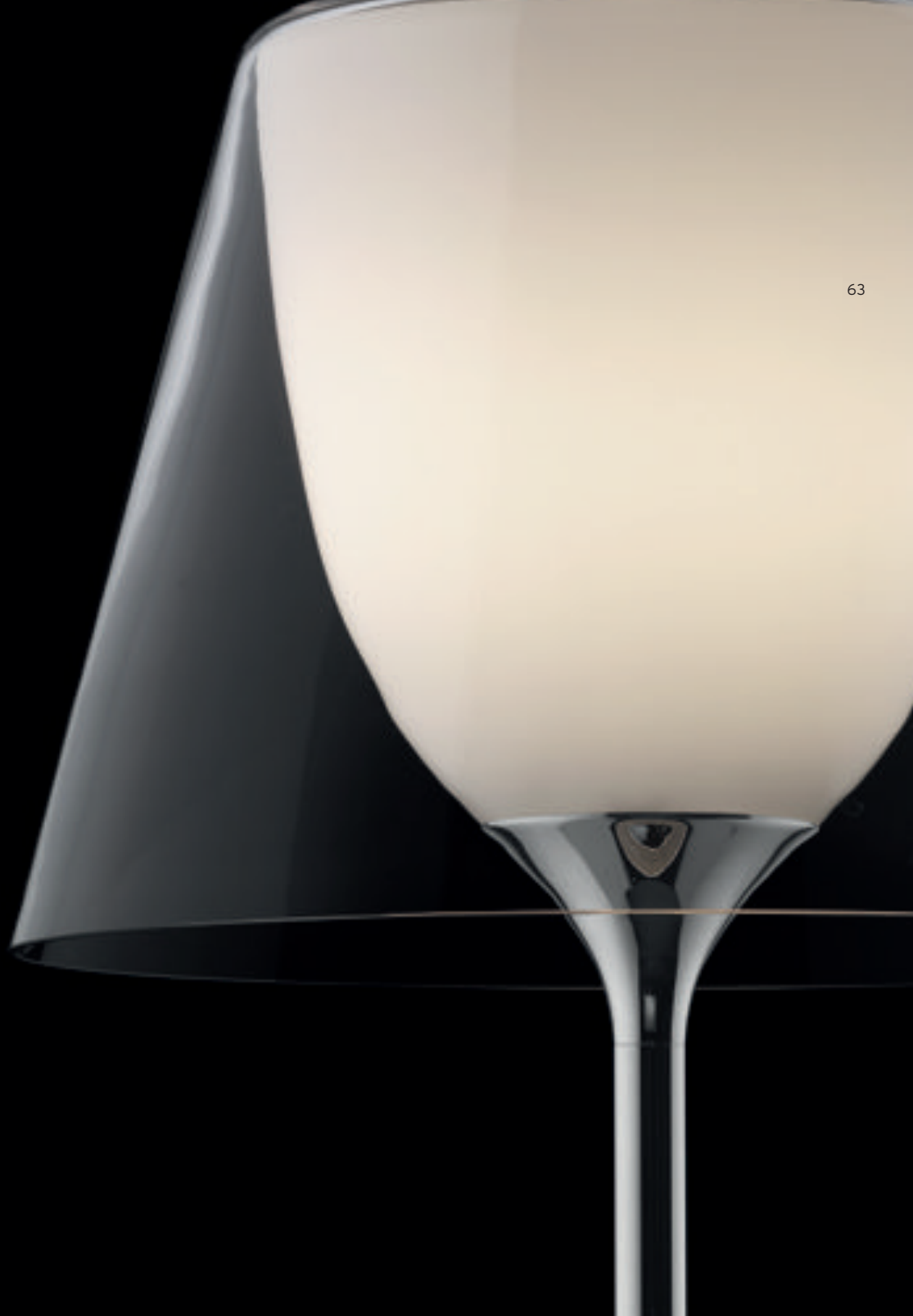

64



GUNS - TABLE GUN

DESIGN PHILIPPE STARCK 2005

LAMP: 1 X 150W BT15 MEDIUM BASE

13,66 (lbs.)

● FU295457 ● FU295400

CONSTRUCTION MATERIALS:
ALUMINUM, PLASTICIZED PAPER

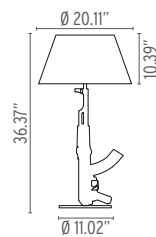





GUNS - BEDSIDE GUN

DESIGN PHILIPPE STARCK 2005

LAMP: 1 X 72W BT15 MEDIUM BASE

3,8 (lbs.)

 FU295357
  FU295300

CONSTRUCTION MATERIALS:
ALUMINUM, PLASTICIZED PAPER

TACCIA TACCIA LED

DESIGN **ACHILLE AND PIER GIACOMO CASTIGLIONI 1962**

TACCIA	LAMP: 1 X 75W PAR 30 MEDIUM BASE	20,72 (lbs.)
--------	----------------------------------	--------------

● FU660004 ○ FU660030

TACCIA LED	LAMP: 1 REMOTE PHOSPHOR LED 2700K 930lm - CRI95 - 17,8W	24,25 (lbs.)
------------	---	--------------

● FU660204 ○ FU660230

CONSTRUCTION MATERIALS: METAL, GLASS, ALUMINUM

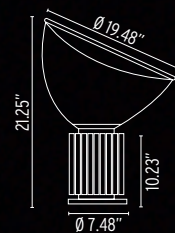



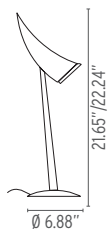

**ARÀ**DESIGN **PHILIPPE STARCK 1988**

LAMP: 1 X 35W 12V MR11 GU4

4,62 (lbs.)

● FU025057

CONSTRUCTION MATERIALS:
ALUMINUM, GLASS, STEEL, ZAMAK



MISS K

DESIGN PHILIPPE STARCK 2003

LAMP: 1 X 72W BT15 MEDIUM BASE

2,62 (lbs.)

FU625535
 FU625500
 FU625530
 FU625507

CONSTRUCTION MATERIALS:
POLYMETHYLMETHACRYLATE, POLYCARBONATE, FABRIC

CERTIFICATIONS:

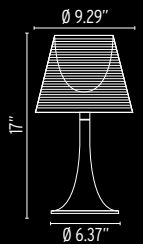





SPUN LIGHT T

DESIGN SEBASTIAN WRONG 2003

SPUN LIGHT T1	LAMP: 1 X 72W T10 MEDIUM BASE	9,47 (lbs.)
---------------	-------------------------------	-------------

○ FU661009 ● FU661030 ● FU661021 || FU661050

SPUN LIGHT T2	LAMP: 1 X 150W T10 MEDIUM BASE	12,34 (lbs.)
---------------	--------------------------------	--------------

○ FU661109 ● FU661130 ● FU661121 || FU661150

CONSTRUCTION MATERIALS:
ALUMINUM, GLASS, STEEL

CERTIFICATIONS:

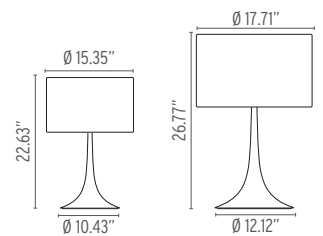



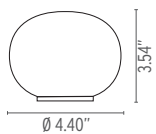

**MINI GLO-BALL T**DESIGN **JASPER MORRISON 2003**

LAMP: 1 X 25W T4 G9 FROSTED

0.88 (lbs.)

○ FU419109

CONSTRUCTION MATERIALS: GLASS, PBT

**GLO-BALL BASIC ZERO**

DESIGN JASPER MORRISON 2009

LAMP: 1 X 40W G9 T4

2,2 (lbs.)

○ FU333109

CONSTRUCTION MATERIALS:
ALUMINUM, BLOWN GLASS, PLASTIC

CERTIFICATIONS:

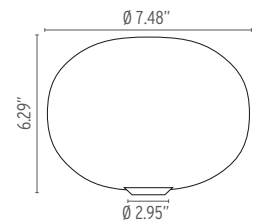





GLO-BALL BASIC

DESIGN JASPER MORRISON 1998

BASIC 1 *	LAMP: 1 X 100W T8 E26 MEDIUM BASE	○ FU302100	5,73 (lbs.)
BASIC 2 **	LAMP: 1 X 150W BT15 MEDIUM BASE	○ FU302600	11,68 (lbs.)
CONSTRUCTION MATERIALS: ALUMINUM, BLOWN GLASS, PLASTIC			CERTIFICATIONS: *UL **cUL

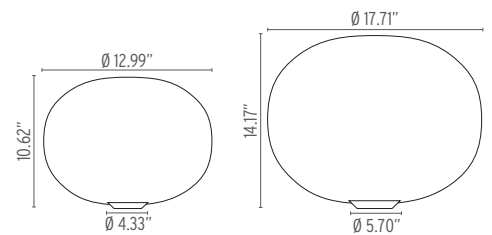







GLO-BALL T

DESIGN JASPER MORRISON 1998

T1	LAMP: 1 X 100W T8 E26 MEDIUM BASE	● FU302000	15.43 (lbs.)
T2	LAMP: 1 X 150W BT15 MEDIUM BASE	● FU302500	26.89 (lbs.)
CONSTRUCTION MATERIALS: ALUMINUM, BLOWN GLASS, STEEL			CERTIFICATIONS:  

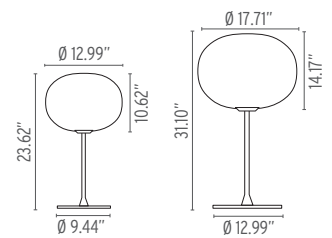





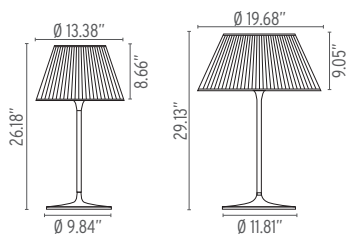

ROMEO MOON T

DESIGN PHILIPPE STARCK 1998

T1	LAMP: 1 X 72W BT15 MEDIUM BASE FROSTED	 FU610100	16,97 (lbs.)
T2	LAMP: 1 X 150W BT15 MEDIUM BASE FROSTED	 FU610200	35,27 (lbs.)

CONSTRUCTION MATERIALS:
ALUMINUM, GLASS, POLYCARBONATE, STEEL



ROMEO SOFT T

DESIGN PHILIPPE STARCK 1998

T1	LAMP: 1 X 72W BT15 MEDIUM BASE FROSTED	 FU610107	11,68 (lbs.)
T2	LAMP: 1 X 150W BT15 MEDIUM BASE FROSTED	 FU610207	19,84 (lbs.)

CONSTRUCTION MATERIALS:
FABRIC, GLASS, STEEL, ALUMINUM

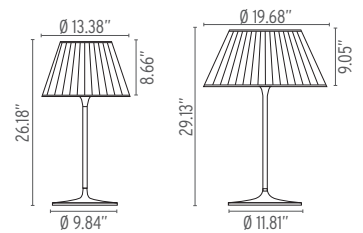



AOYDESIGN **ACHILLE CASTIGLIONI 1975****LAMPS:** 1 X 100W SILVERED BULB A19 MED +
1 X 100W A19 FROSTED MEDIUM BASE

26.67 (lbs.)

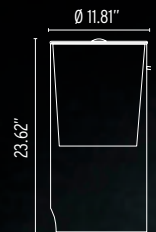
● **FU020071****CONSTRUCTION MATERIALS:**
GLASS





SNOOPY

DESIGN **ACHILLE AND PIER GIACOMO CASTIGLIONI 1967**

LAMP: 1 X 100W A19 MEDIUM BASE

17,41 (lbs.)

● FU638030

CONSTRUCTION MATERIALS:
MARBLE, STEEL

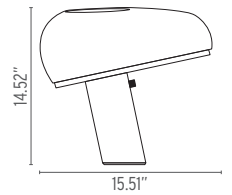

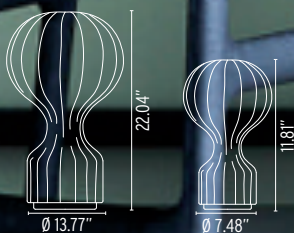

GATTO - GATTO PICCOLO

DESIGN **ACHILLE AND PIER GIACOMO CASTIGLIONI** 1960

GATTO	LAMP: 1 X 60W A19 MEDIUM BASE	5,07 (lbs.)
-------	-------------------------------	-------------

● FU260109

GATTO PICCOLO	LAMP: 1 X 60W G16.5 CANDELABRA	1,98 (lbs.)
---------------	--------------------------------	-------------

● FU270109

CONSTRUCTION MATERIALS:
SYNTHETIC FIBER FOR COCOON, STEEL



BIAGIO

DESIGN TOBIA SCARPA 1968

LAMP: 1 X 72W A19 MEDIUM BASE

16,53 (lbs.)

● F0700000

CONSTRUCTION MATERIALS:
MARBLE

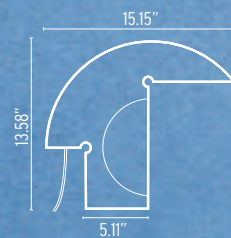





GIBIGIANA

DESIGN **ACHILLE CASTIGLIONI 1980**

GIBIGIANA 1	● FU290233	3,74 (lbs.)
GIBIGIANA 2	● FU280233	4,40 (lbs.)

LAMP: 1 X 20W MR11 GU4

CONSTRUCTION MATERIALS:
ALUMINUM

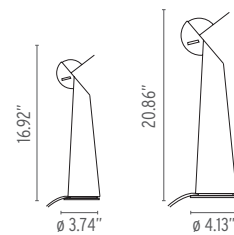

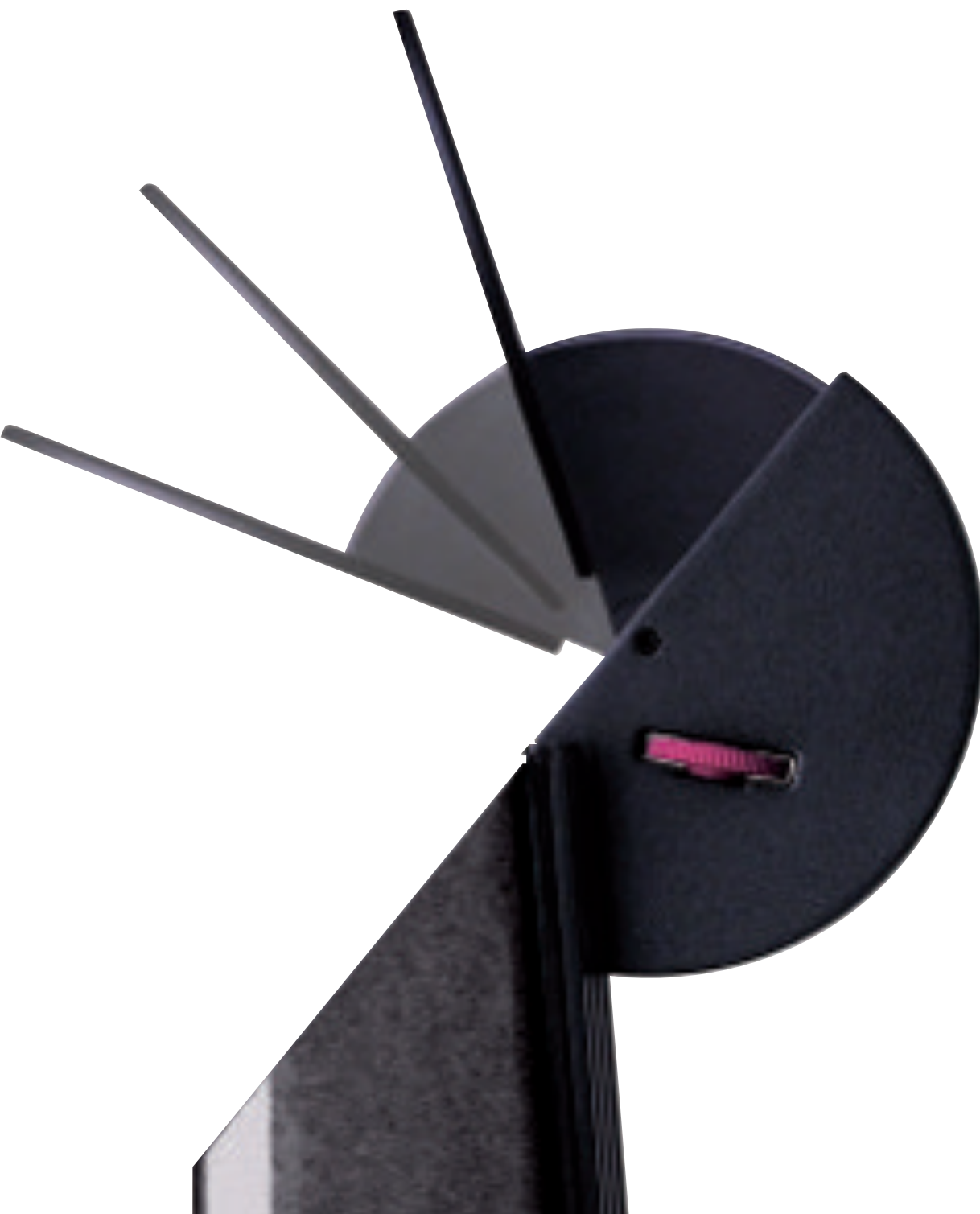



LAMPADINA

DESIGN **ACHILLE CASTIGLIONI** 1972

LAMP: 1 X 40W G40 CLEAR/FROSTED

0,66 (lbs.)

● FU330200 ● FU330275

CONSTRUCTION MATERIALS:
STEEL

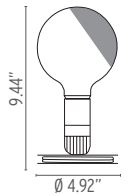

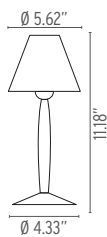

MISS SISSI

DESIGN **PHILIPPE STARCK 1991**

LAMP: 1 x 40W G16.5 CANDELABRA (WHITE VERSION ONLY)
 1 x 60W G16.5 CANDELABRA

3,30 (lbs.)

FU625009
 FU625014

CONSTRUCTION MATERIALS:
 POLYCARBONATE

CERTIFICATIONS:



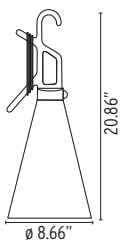

**MAY DAY**

DESIGN KONSTANTIN GRIC 1998

LAMP: 1 X 60W A19 MEDIUM BASE

1,54 (lbs.)

● FU378030 ● FU378002

CONSTRUCTION MATERIALS:
POLYPROPYLENE

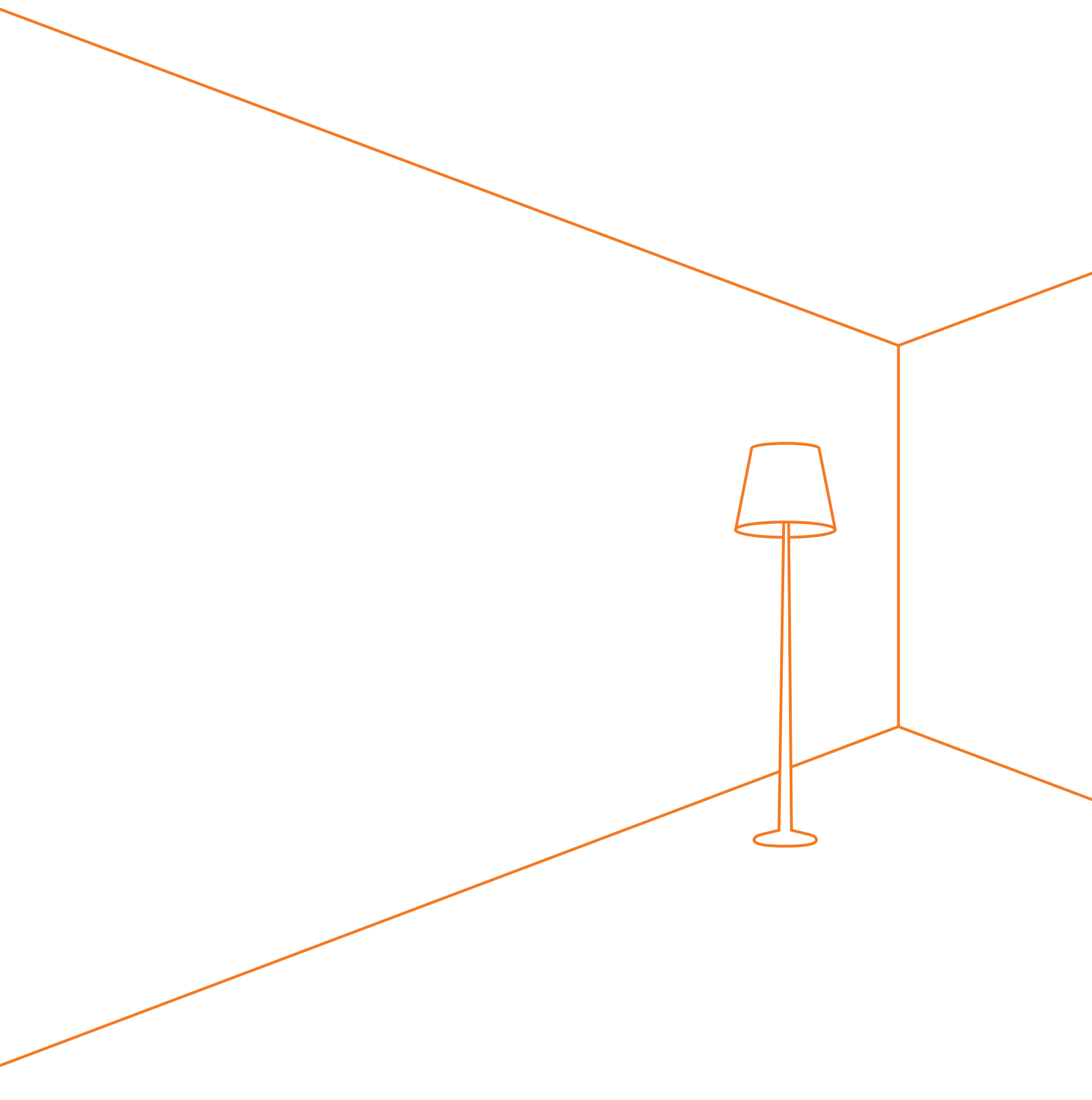

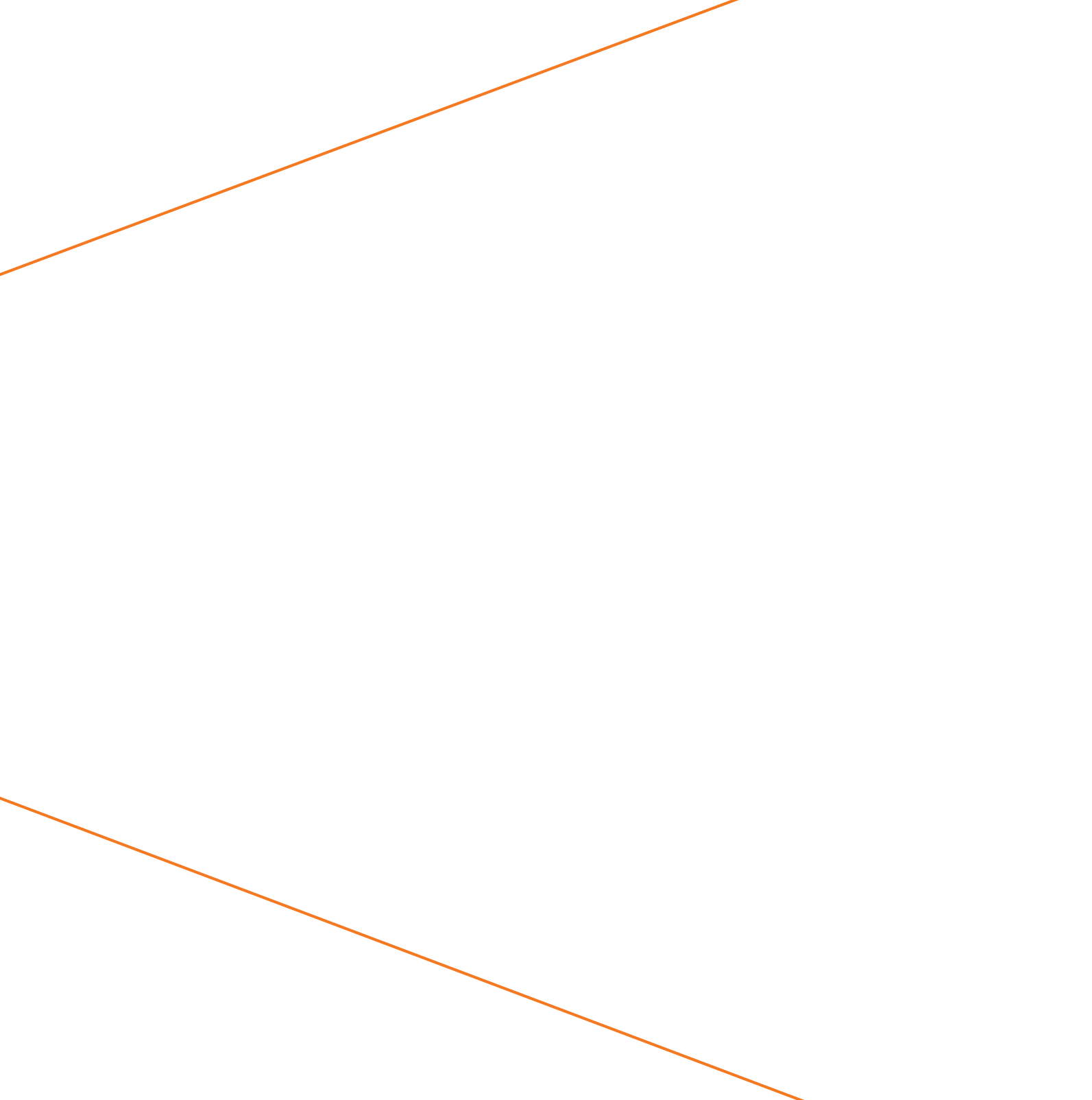

100



ARCO

DESIGN **ACHILLE AND PIER GIACOMO CASTIGLIONI 1962**

LAMP: 1 x 100W HALF SILVER A19 MEDIUM BASE

140,65 (lbs.)

FU030000

CONSTRUCTION MATERIALS:
MARBLE, STAINLESS STEEL, ALUMINUM

CERTIFICATIONS:

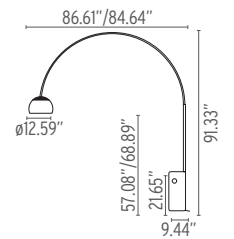

**ARCO LED**DESIGN **ACHILLE AND PIER GIACOMO CASTIGLIONI 1962****LAMP:** 1 MULTICHIP LED 2700K 1150lm CRI93 - 18W (DIMMER)

140,65 (lbs.)

 F0303000**CONSTRUCTION MATERIALS:**
MARBLE, STAINLESS STEEL, ALUMINUM

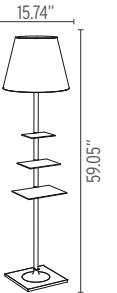



BIBLIOTHEQUE NATIONALE

DESIGN **PHILIPPE STARCK 2013**

LAMP: 150W T10 + CHARGER USB 5VDC

22,8 (lbs.)

● FU101100 ● FU101104 ● FU101130 ● FU101146 ● FU101107

CONSTRUCTION MATERIALS:
STAINLESS STEEL, POLYCARBONATE, POLYMETHYLMETHACRYLATE,
ZAMAK, FABRIC





USB CHARGER

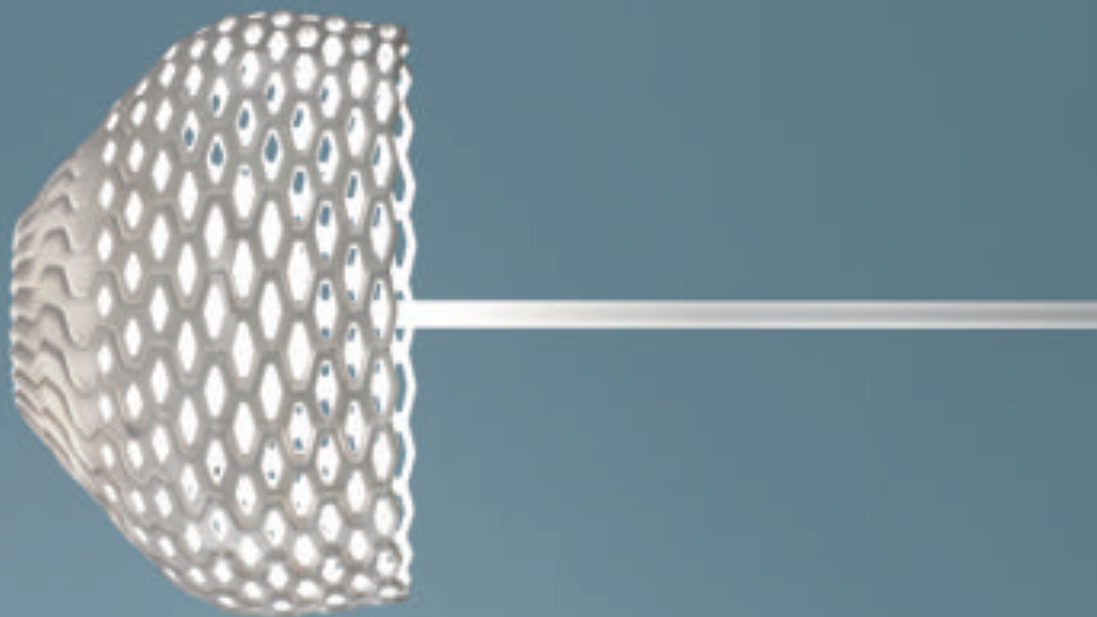

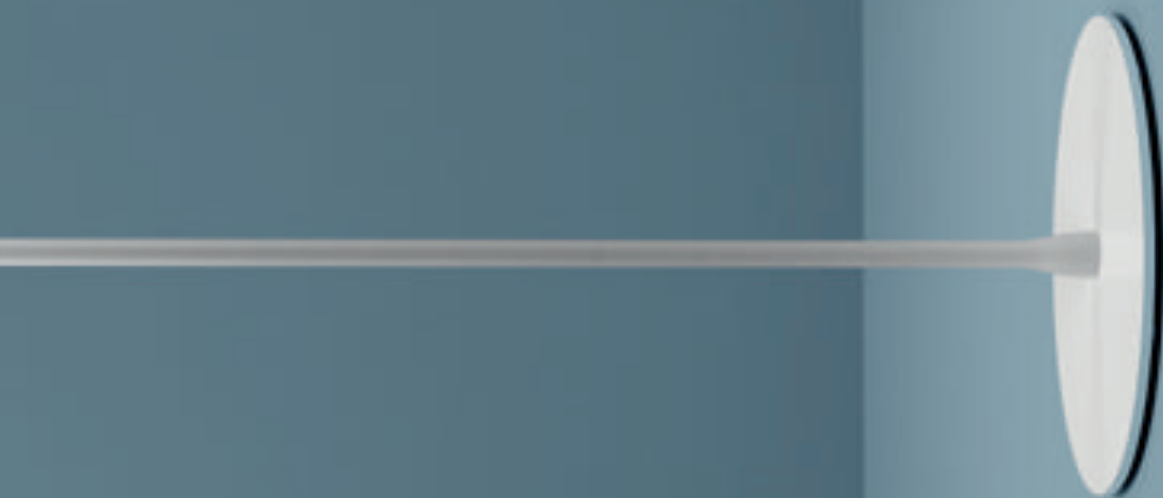





TATOU F

DESIGN PATRICIA URQUIOLA 2012

LAMPS: 1 x 150W BT-15 MEDIUM FROSTED HALOGEN

16.4 (lbs.)

FU776409
 FU776430
 FU776448

CONSTRUCTION MATERIALS:
POLYCARBONATE, STEEL

CERTIFICATIONS:



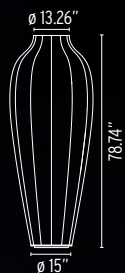

CHRYSALIS

DESIGN MARCEL WANDERS 2011

LAMPS: 1 X 60W T4 CY6.35 HALOGEN +
2 X 54W G5 FSD FLUORESCENT

29,76 (lbs.)

● FU167009

CONSTRUCTION MATERIALS:
SYNTHETIC FIBER FOR COCOON, STEEL, GLASS

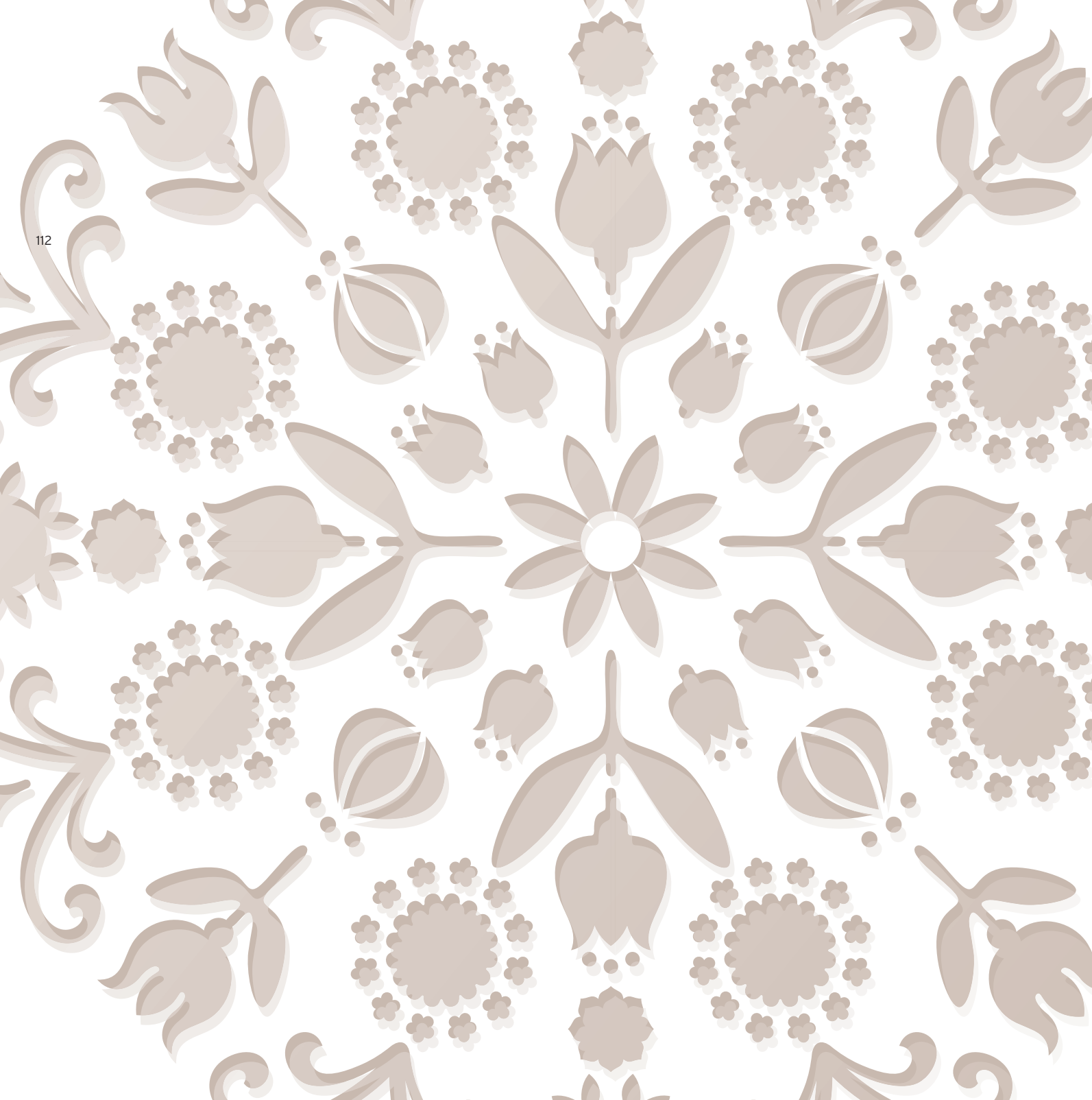

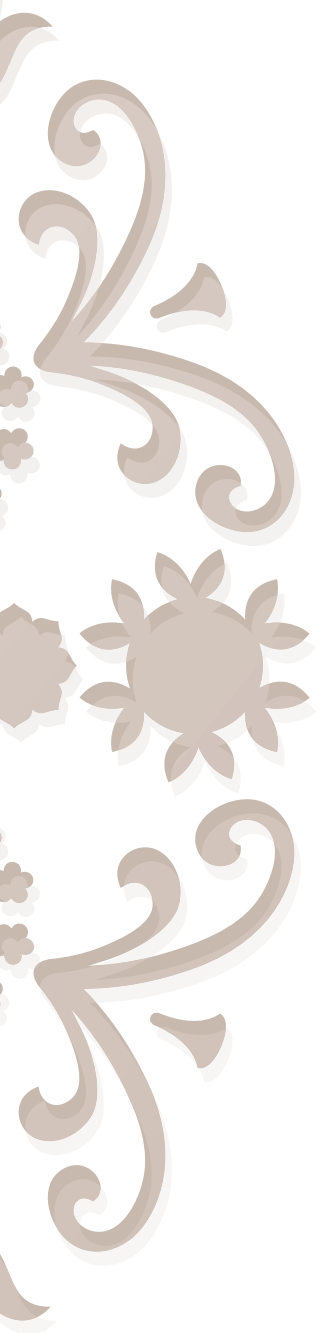



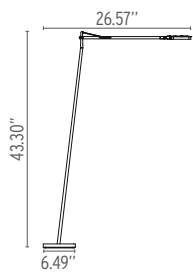

KELVIN LED F

DESIGN **ANTONIO CITTERIO 2011**

LAMP: 30 TOP LED 2700K 275lm total CR195 - 8W (DIMMING)

8.4 (lbs.)

● F3305030 ○ F3305009 ● F3305033

CONSTRUCTION MATERIALS:
ALUMINUM

CERTIFICATIONS:



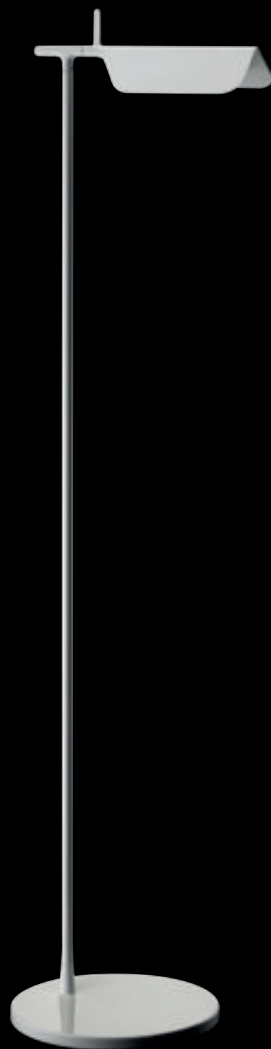

TAB F

DESIGN E. BARBER & J. OSGERBY 2011

LAMP: 14 LED 3000K 425lm CRI 80 - 5W

4,41 (lbs.)

○ F6561030 ● F6561009

CONSTRUCTION MATERIALS:
DIE-CAST ALUMINUM, PMMA

CERTIFICATIONS

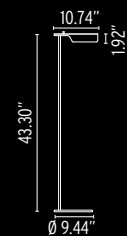



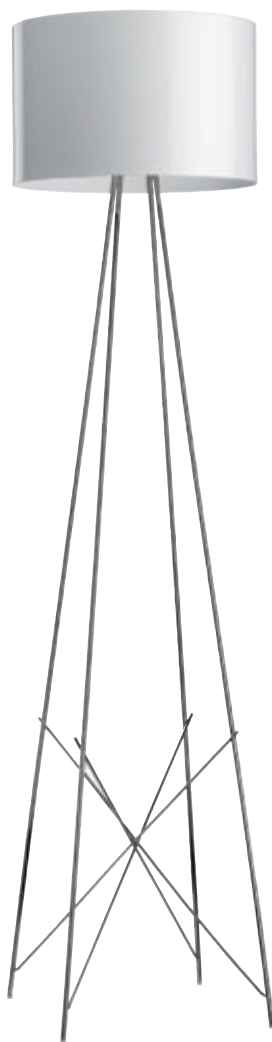

RAY F

DESIGN **RODOLFO DORDONI 2007**

RAY F1	LAMP: 1 X 150W BT15 MEDIUM BASE	11,02 (lbs.) METAL 17,63 (lbs.) GLASS
● FU591630 ○ FU591609 ● FU591520		
RAY F2	LAMP: 1 X 150W BT15 MEDIUM BASE	13,66 (lbs.) METAL 20,28 (lbs.) GLASS
● FU592130 ○ FU592109 ● FU592020		

CONSTRUCTION MATERIALS:
ALUMINUM, GLASS, NYLON, POLYCARBONATE, PVC, STEEL, ZAMAK

CERTIFICATIONS:

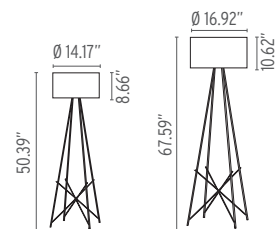



120



TOIO

DESIGN **ACHILLE AND PIER GIACOMO CASTIGLIONI 1962**

LAMP: 1 x 300W PAR 56 MEDIUM

18,07 (lbs.)

● FU760030 ● FU760035

CONSTRUCTION MATERIALS:
BRASS, STEEL





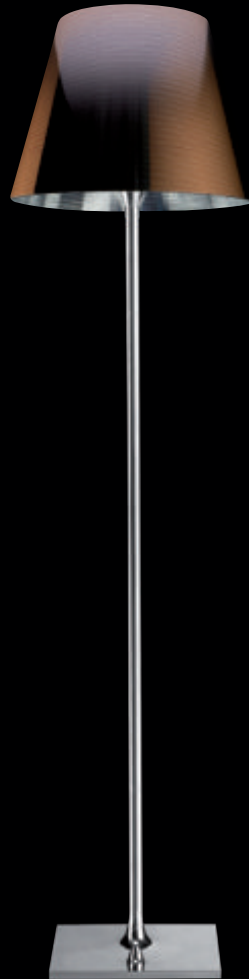

KTRIBE F2

DESIGN PHILIPPE STARCK 2007

LAMP: 1 X 150W BT15 MEDIUM BASE

● FU630500 ● FU630504 ● FU630530 ● FU630546 ● FU630507

CONSTRUCTION MATERIALS:

DIE-CAST ALUMINUM, POLYCARBONATE, POLYMETHYLMETHACRYLATE, ZAMAK, FABRIC

14,7 (lbs.)

CERTIFICATIONS:

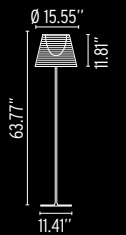



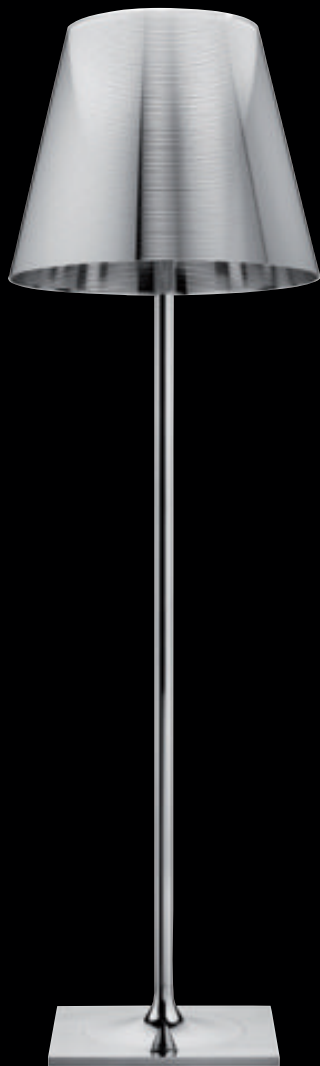

KTRIBE F3

DESIGN PHILIPPE STARCK 2007

LAMP: 1 X 150W BT15 MEDIUM BASE

● FU630100 ● FU630104 ● FU630130 ● FU630146 ● FU630107

CONSTRUCTION MATERIALS:

DIE-CAST ALUMINUM, POLYCARBONATE, POLYMETHYLMETHACRYLATE, ZAMAK, FABRIC

30,86 (lbs.)

CERTIFICATIONS:

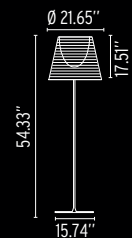



**SPUN LIGHT F**DESIGN **SEBASTIAN WRONG 2003**

LAMP: 1 x 200W A21 MEDIUM BASE

20.5 (lbs.)

○ FU661209 ● FU661230 ● FU661221 || FU661250

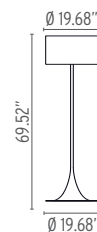

CONSTRUCTION MATERIALS:
ALUMINUM, GLASS, STEEL





GLO-BALL F

DESIGN JASPER MORRISON 1998

GLO-BALL F1	LAMP: 1 X 100W T8 E26 MEDIUM BASE	● FU303120	26,46 (lbs.)
GLO-BALL F2	LAMP: 1 X 150W BT15 MEDIUM BASE	● FU303220	27,56 (lbs.)
GLO-BALL F3	LAMP: 1 X 250W T10 MEDIUM BASE	● FU303000	41,67 (lbs.)
CONSTRUCTION MATERIALS: GLASS, STEEL			CERTIFICATIONS:  

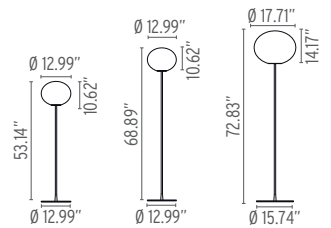





ROMEO MOON F

DESIGN PHILIPPE STARCK 1996

ROMEO MOON F

LAMP: 1 x 150W BT15



FU610300

52,47 (lbs.)

CONSTRUCTION MATERIALS:

ALUMINUM, GLASS, POLYCARBONATE, STEEL

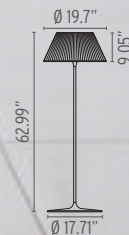



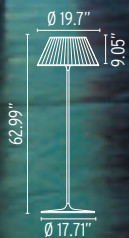



ROMEO SOFT F

DESIGN PHILIPPE STARCK 1998

ROMEO SOFT F

LAMP: 1 x 150W BT15 MEDIUM BASE FROSTED

37,04 (lbs.)

FU610307

CONSTRUCTION MATERIALS:
FABRIC, GLASS, STEEL, ALUMINUM

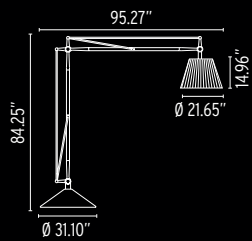



SUPERARCHIMOOON

DESIGN PHILIPPE STARCK 2000

LAMP: 1 x 250W T10 MEDIUM BASE

200,62 (lbs.)

● FU637020

CONSTRUCTION MATERIALS:
FABRIC, GLASS, STEEL, ALUMINUM

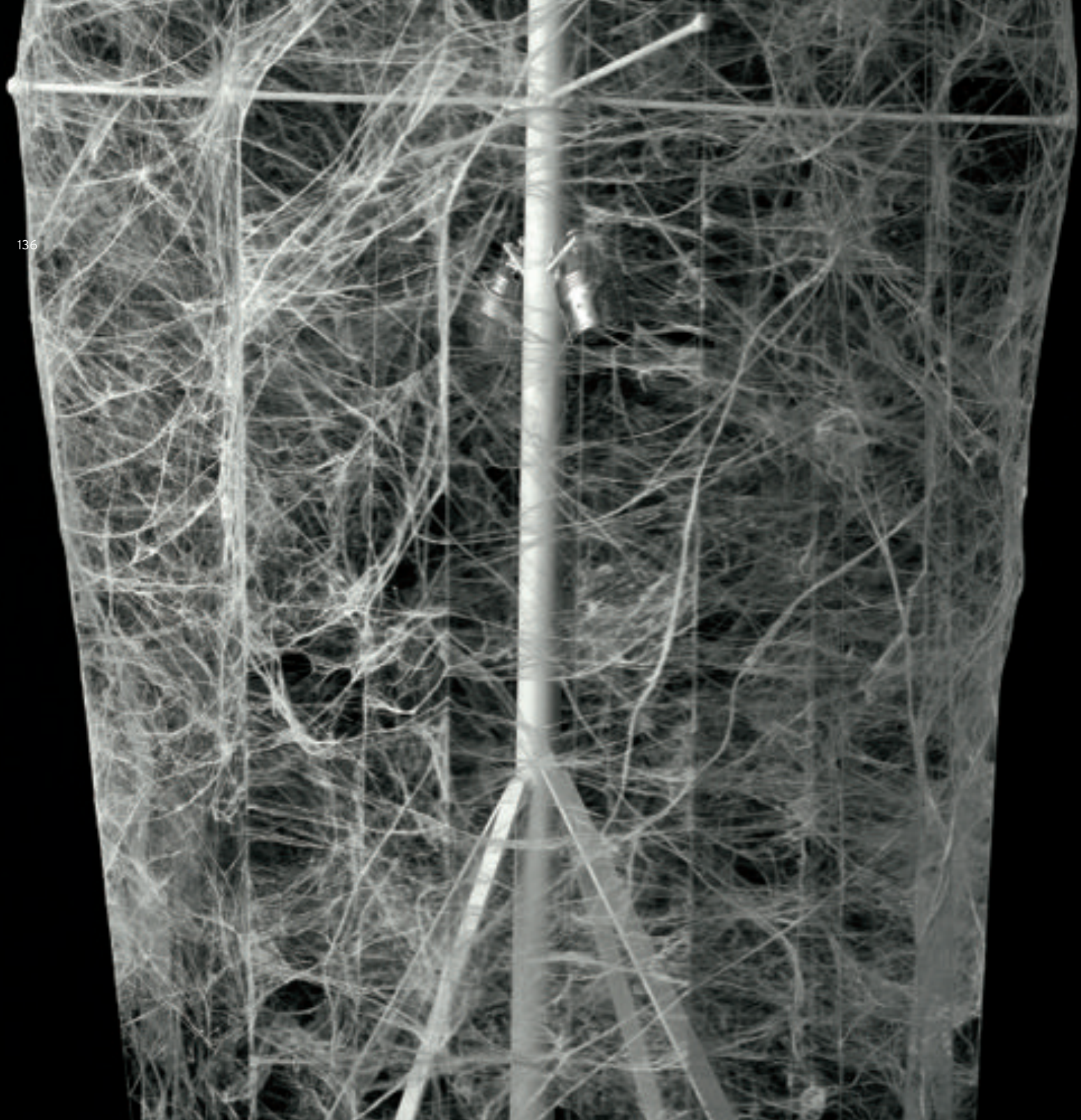

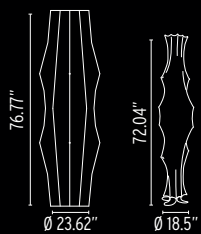

FANTASMA - FANTASMA PICCOLO

DESIGN TOBIA SCARPA 1961

FANTASMA	LAMPS: 4 X 72W BT15 MEDIUM BASE	23,15 (lbs.)
----------	---------------------------------	--------------

● FU220109		
------------	--	--

FANTASMA PICCOLO	LAMPS: 3 X 72W BT15 MEDIUM BASE	22,05 (lbs.)
------------------	---------------------------------	--------------





● FU210109		
------------	--	--

CONSTRUCTION MATERIALS:
SYNTHETIC FIBER FOR COCOON, STEEL



BRERA F

DESIGN **ACHILLE CASTIGLIONI 1992**

BRERA F1	 FU141057	13,67 (lbs.)
BRERA F2	 FU141157	14,33 (lbs.)
BRERA F3	 FU141257	14,55 (lbs.)
LAMP: 1 X 72W BT15 MEDIUM BASE		CERTIFICATIONS:
CONSTRUCTION MATERIALS: GLASS, POLYCARBONATE, STEEL		 

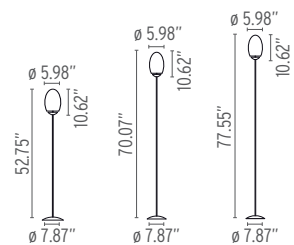

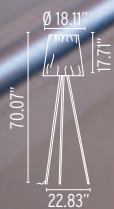

ROSY ANGELIS

DESIGN PHILIPPE STARCK 1994

LAMP: 1 X 150W A21 MEDIUM BASE

3.53 (lbs.)

FU616020

CONSTRUCTION MATERIALS:
FABRIC, ALUMINUM

140



STYLOS

DESIGN ACHILLE CASTIGLIONI 1984

LAMPS: 1 x 120W PAR 38 FLOOD MEDIUM BASE +
1 x 100W MEDIUM SUPERFLUX

21,16 (lbs.)

● FU631004

CONSTRUCTION MATERIALS:
POLYMETHYLMETHACRYLATE, STEEL







A LA VIE, A LA MORT

POIS ILY QUT DES ESSAIS DE VIE, POIS UNE
EBAUCHE DE VIE, POIS LA VIE.

ELLE AVAIT PAS GRANDE VALEUR, VIE ET MORT
CONFONDU, UN PEU AU HASARD, SANS
IMPORTANCE.

MAIS ON A TRAVAILÉ. BEAUCOUP.

ON A CREE UNE CIVILISATION POUR QUE LA VIE
VIVE.

FORCEMENT SUBLIME, DEVENUE SACRÉ, INTOUCHABLE,
LA GRANDE, LA BELLE VIE, GARANTIE POUR
TOUT LE MONDE, A VECU ET SUR-VECU
JUSQU'A NOUS, TROISIEME VINGT ET UNIEME
SIECLE, TROISIEME MILLENAIRE, AVENEMENT
DE LA CIVILISATION CIVILISEE.

BRavo, DORMIR EN PAIX

PATATNAS

C'EST JAMAIS COMME ON CROIT.

A PEINE VECU UN PETIT CYCLE DE LUMIERES
L'OMBRE REVIENT, RAPIDE, DENSE, MENACANT
RETOUR ARRIERE, LA MORT GUTTE.

Aujourd'hui on tue, ~~par~~ religieusement,
MILITAIREMENT, CIVILEMENT, quelquefois
FORT CIVILEMENT, PAR AMBITION,
PAR AVIDITE, POUR LE PLAISIR, POUR LE
SPECTACLE.

LES REPUBLIQUES SONT BANANIERES
NOUS MAINTS DES TYRANS
CRIES, FABRIQUES, VENDUES, REVUES,
ACHETES, UTILISEES, NOS NOUVELLES
ICONES SONT DES ARMES.

LA COLLECTION

~~NOUS~~ NOS VIES NE VALENT QU'UNE CARTOUCHE.
LA COLLECTION "GUNS" EST UN SIGNE ~~DE~~ DU
TEMPS.

ON A LES SYMBOLES QUE L'ON MERITE

HATYNEW IS A HOT GUN
GLOIRE A NOS DICTATEURS
A LA VIE, A LA MORT.

PH.S.

P.S :

LEGER, FONCTIONNEL, FIABLE, PAS ABORDABLE,
ELEGANTE; AVEC PLUS DE 100 MILLIONS
D'EXEMPLAIRES OFFICIELLEMENT PRODUITS, LA
KALACHNIKOU EST UN DE PLUS GRANDS
SUCCES DE DESIGN INDUSTRIEL DE NOTRE
GENERATION.

M^r KALACHNIKOU NE TOUCHE PAS DE
ROYAUTES. IL S'EN PLAINT SOUVENT.

JE VOUSOIS DONC UNE COMMISSION A M^r
KALACHNIKOU SUR LES VENTES DE LA
REPRESENTATION DE SON MODELE. LE PAUVRE.
LE RESTE SERA VERSÉ A "FRÈRES DES
HOMMES EUROPE". JE ME DEMANDE

BIEN POURQUOI.

AUX LARMEI CITOYENS
AUX ARMEI CITOYENS.

PH.S.

EXPLICATION :

- L'OR SUR LES ARMES REPRESENTE LA
COLLUSION DE L'ARGENT ET DE LA GUERRE.
- TABLE GUN REPRESENTE L'EST
- BESIDE GUN EUROPE.
- LOUNGE GUN L'OUEST.
- LE 'ABAJON NOIR REPRESENTE LA
MORT
- LES CROIX A L'INTERIEUR NOUS
RAPPELE NOS MORTS.



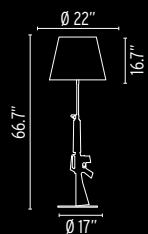

GUNS - LOUNGE GUN

DESIGN PHILIPPE STARCK 2005

LAMP: 1 X 200W A21 MEDIUM BASE

43 (lbs.)

● FU295557 ● FU295500

CONSTRUCTION MATERIALS:
ALUMINUM, PLASTICIZED PAPER

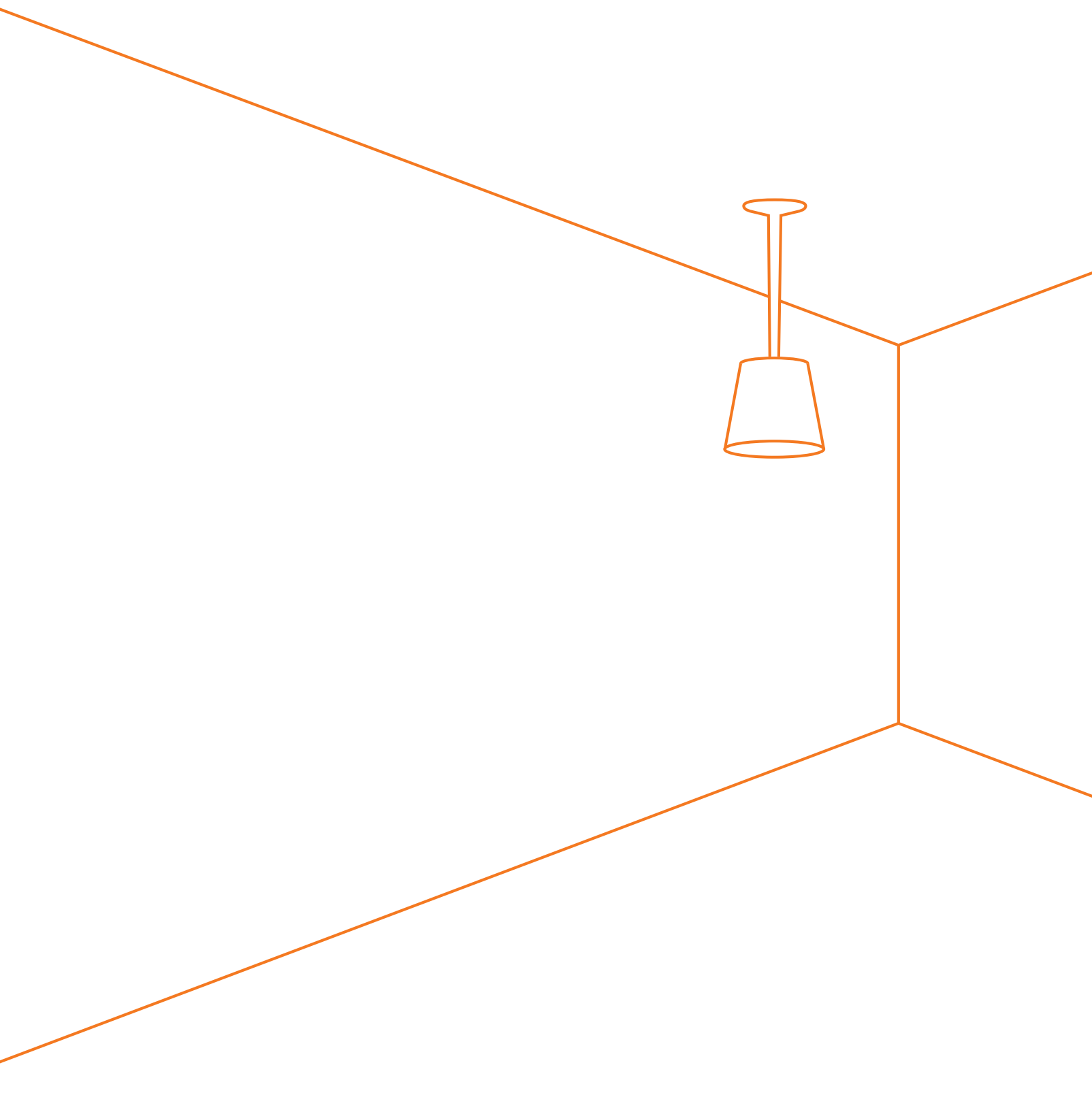

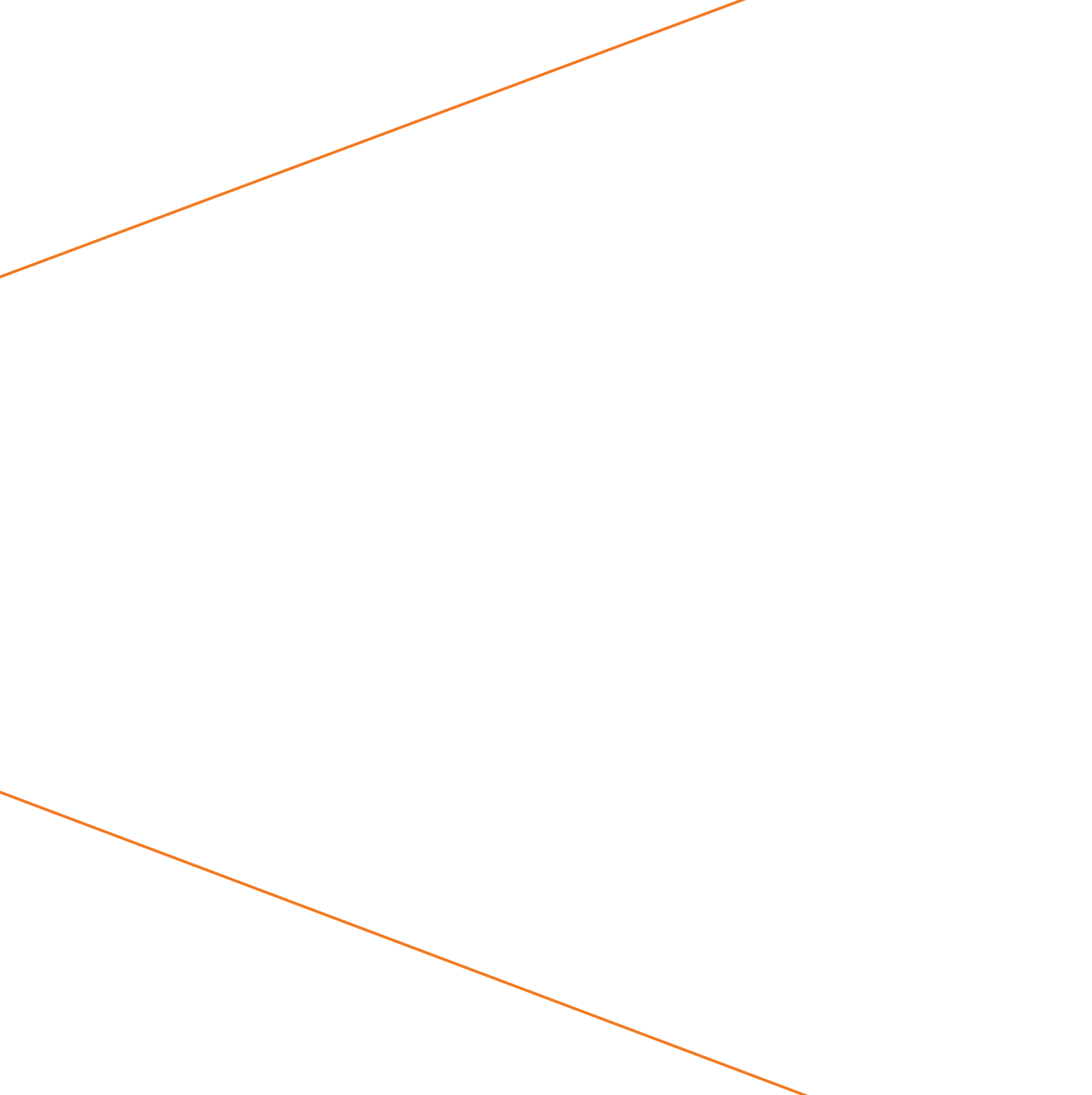



**AIM**

DESIGN R. & E. BOUROLLEC 2013

LAMP: 1 LED 2700K 1250lm CRI 82 - 20W

7,05 (lbs.)

● FU009009 ● FU009030 ● FU009050

CONSTRUCTION MATERIALS:
ALUMINIUM, POLYCARBONATE

CERTIFICATIONS:



150

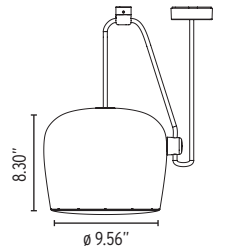





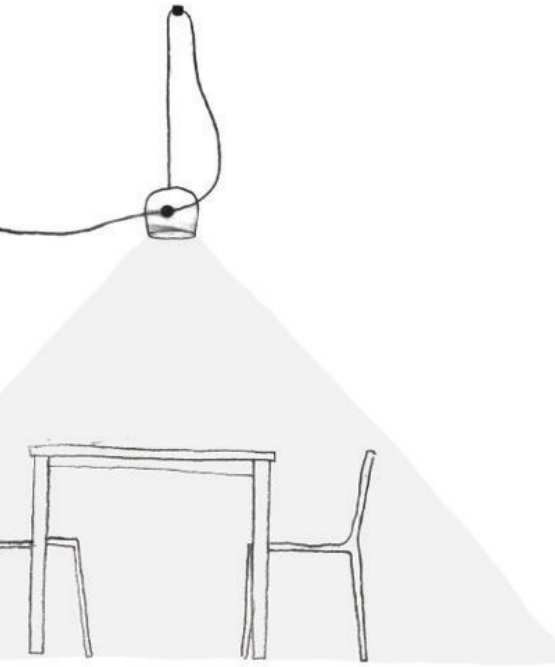

Single module
to light a painting

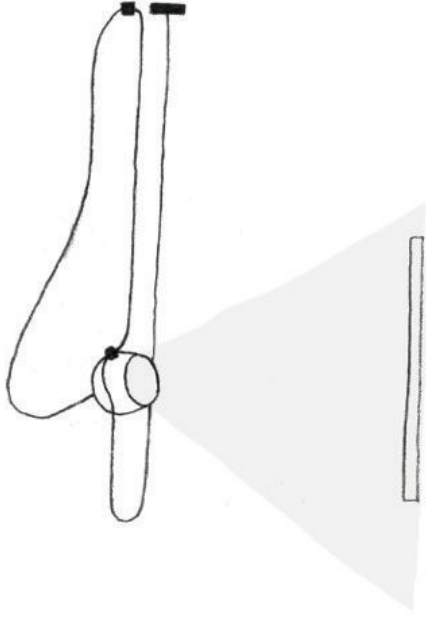

Single module plugged
into wall outlet.

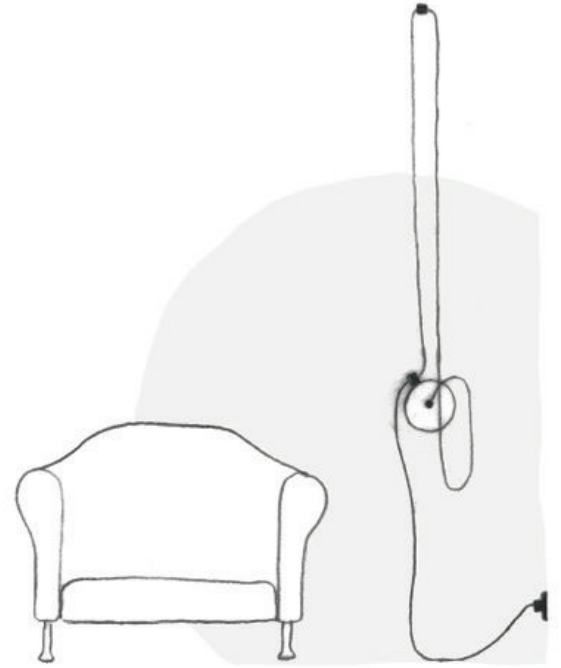

room of room *Design*

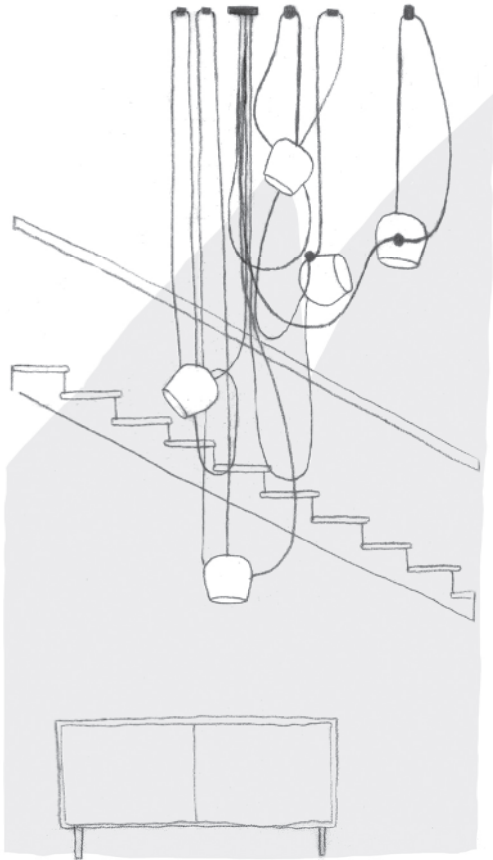

Multiple module
for an entrance hall

room at some time







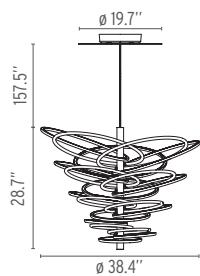

2620

DESIGN **RON GILAD 2013**

LAMP: 2620 CHIP LED 3000K - 11200LM TOTAL - CRI85 - 200W

39,7 (lbs.)

○ F0031009

CONSTRUCTION MATERIALS:
ALUMINUM, METHACRYLATE, STEEL







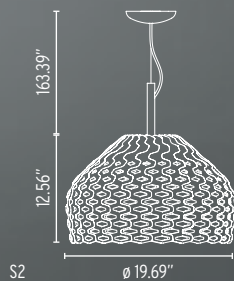
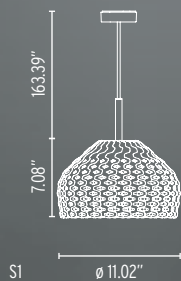

TATOU S1/S2

DESIGN PATRICIA URQUIOLA 2012

TATOU S1	LAMP: 1 X MAX 23W E26 TYPE SBCLF	2,64 (lbs.)
● FU776209	● FU776230	● FU776248
TATOU S2	LAMPS: 1 x 150W T10 MEDIUM FROSTED HALOGEN	10,36 (lbs.)
● FU776609	● FU776630	● FU776648

CONSTRUCTION MATERIALS:
POLYCARBONATE, STEEL

CERTIFICATIONS:



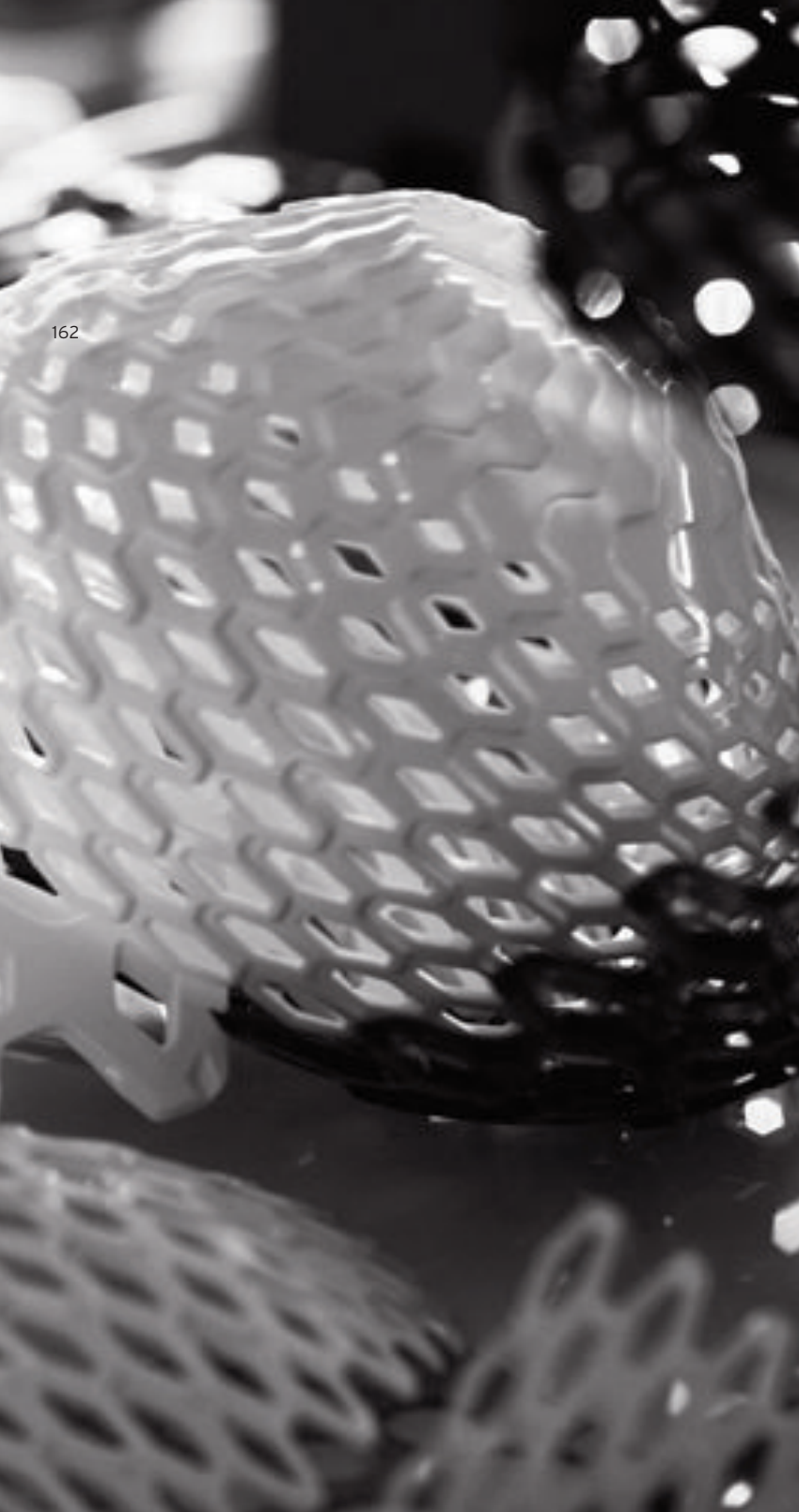

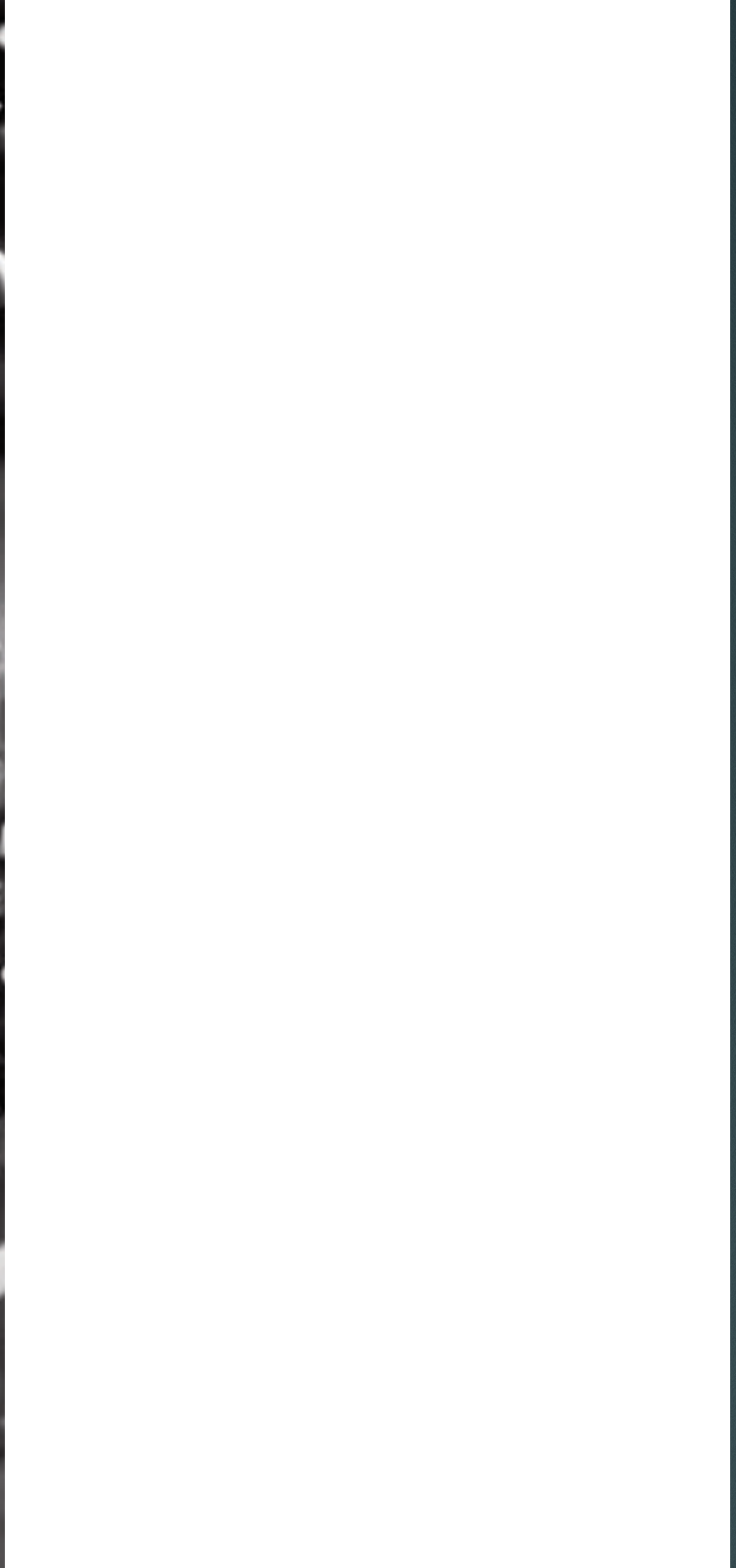

162



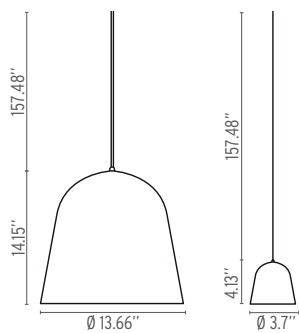





CAN CAN		
DESIGN MARCEL WANDERS 2011		
CAN CAN *	LAMP: 1 x 72W BT15 MEDIUM BASE or 1 X FL E26	5,07 (lbs.)
● FU155230 ● FU155430 ● FU155330		
○ FU155209 ○ FU155409 ○ FU155309		
MINI CAN CAN	LAMP: 1 x 20W G9 FROSTED HALOGEN	2,5 (lbs.)
● FU156030 ○ FU156009		
CONSTRUCTION MATERIALS: POLYMETHYLMETHACRYLATE		CERTIFICATIONS: * 











SMITHFIELD S

DESIGN JASPER MORRISON 2009

SMITHFIELD S	LAMP: 1 x 200W T3 R7S CLEAR	11 (lbs.)
● FU136030 ○ FU136009 ● FU136021		
SMITHFIELD S ECO	LAMPS: 3 x 24W 2G11	
● FU136130 ○ FU136109 ● FU136121		
CONSTRUCTION MATERIALS: ALUMINUM, POLYCARBONATE		CERTIFICATIONS: 

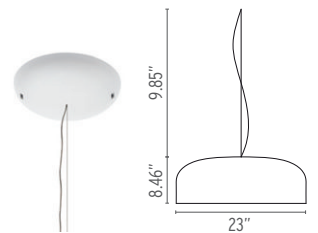





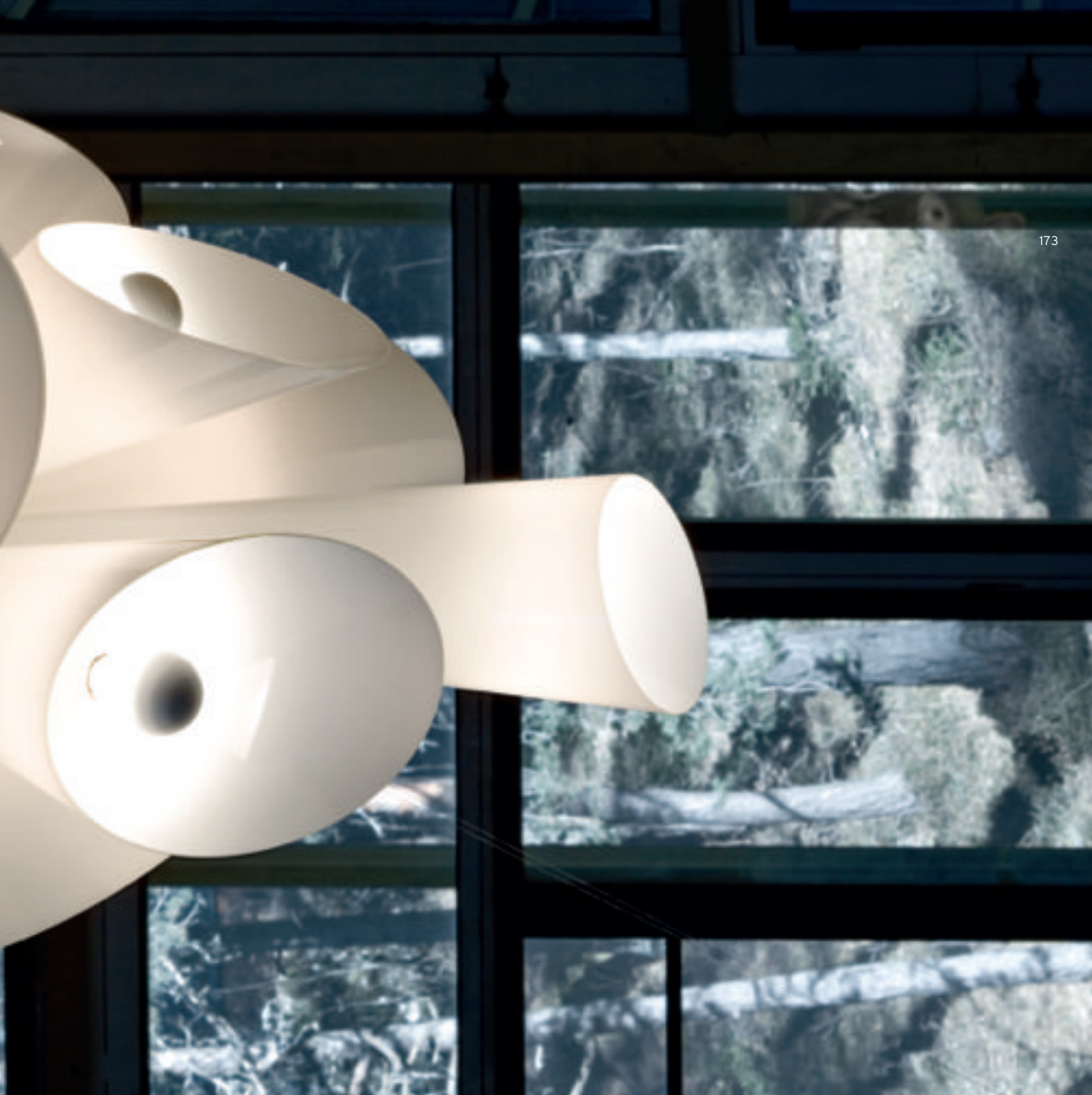



NEBULA

DESIGN **JORIS LAARMAN 2007**

LAMPS: 8 x 100W TYPE A21 WITH SILVER DOME +
4 x 150W TYPE BT15

83,78 (lbs.)

● FU455009

CONSTRUCTION MATERIALS:
ALUMINUM, DIE-CAST ALUMINUM, GLASS,
POLYCARBONATE, STEEL

CERTIFICATIONS:

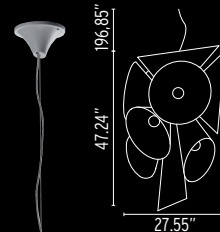





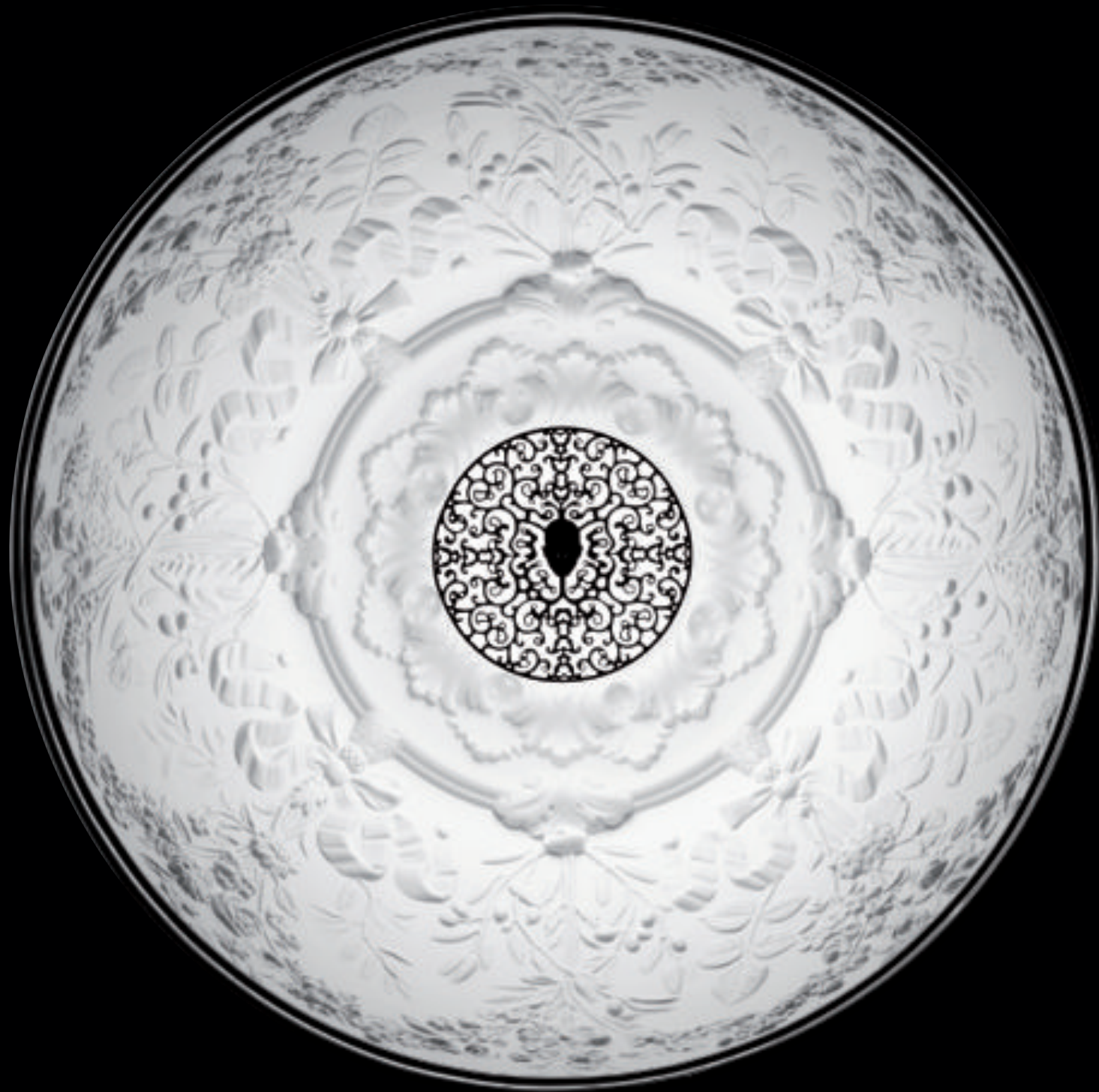





SKYGARDEN

DESIGN MARCEL WANDERS 2007

SKYGARDEN 1	LAMP: 1 x 150W T10 MEDIUM BASE	29,9 (lbs.)
 FU641044 FU641047 FU641009 FU641030		
SKYGARDEN 2	LAMP: 1 x 250W T10 MEDIUM BASE	52,9 (lbs.)
 FU642044 FU642047 FU642009 FU642030		
CONSTRUCTION MATERIALS: PLASTER, GLASS, STAINLESS STEEL		CERTIFICATIONS:  

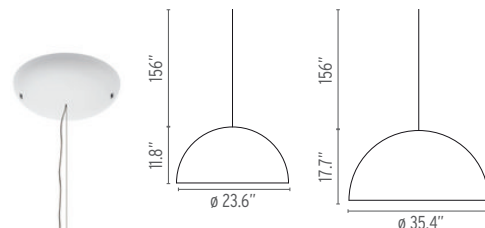



**CHASEN**DESIGN **PATRICIA URQUIOLA 2007**

LAMP: 1 x 120W BR-40 MEDIUM

14,33 (lbs.)

 FU163609 FU163630CONSTRUCTION MATERIALS:
STAINLESS STEEL, ALUMINUM, GLASS

CERTIFICATIONS:

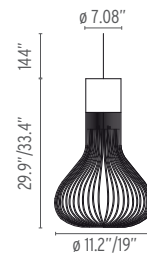







**LONG & HARD**

DESIGN PHILIPPE STARCK 2005

LAMP: 105 LED 2700K 1260LM CRI 93 - 20W

7,72 (lbs.)

FU338050

CONSTRUCTION MATERIALS:
ALUMINUM, DIE-CAST ALUMINUM,
POLYCARBONATE, STEEL

CERTIFICATIONS:

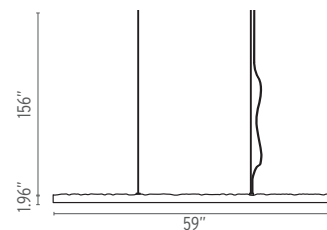





Marcel Breuer with Achille and Pier Giacomo Castiglioni at the Gavina store in Milan, 1962.





ZEPPELIN

DESIGN MARCEL WANDERS 2005

ZEPPELIN 1	LAMP: 1 x 200W A-21 MEDIUM FROSTED INCANDESCENT	33,07 (lbs.)
------------	---	--------------

● FU980009

ZEPPELIN 2	LAMPS: 3 x 150W T10 MEDIUM BASE FROSTED	66,14 (lbs.)
------------	---	--------------

● FU980509

CONSTRUCTION MATERIALS:
SYNTHETIC FIBER FOR COCOON, STEEL, CRYSTAL

CERTIFICATIONS:

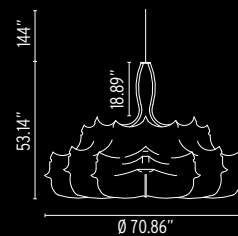
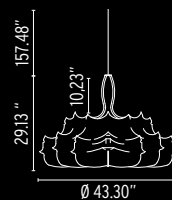



**VISCONTEA**DESIGN **ACHILLE AND PIER GIACOMO CASTIGLIONI 1960**

LAMP: 1 x 150W T10 MEDIUM BASE FROSTED

3,75 (lbs.)

● FU800109

CONSTRUCTION MATERIALS:
SYNTHETIC FIBER FOR COCOON, STEEL

CERTIFICATIONS:

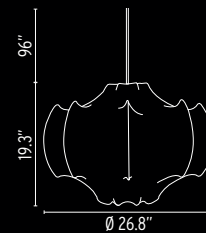

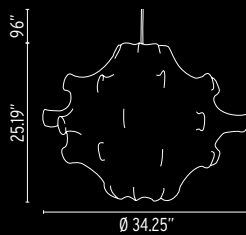
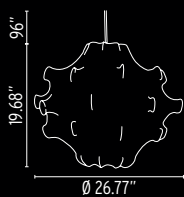

TARAXACUM

DESIGN **ACHILLE AND PIER GIACOMO CASTIGLIONI 1960**

TARAXACUM 1	LAMP: 1 x 150W T10 MEDIUM BASE FROSTED	4.63 (lbs.)
-------------	--	-------------

● FU740109

TARAXACUM 2	LAMP: 1 x 150W T10 MEDIUM BASE FROSTED	6.17 (lbs.)
-------------	--	-------------

● FU740209

CONSTRUCTION MATERIALS:
SYNTHETIC FIBER FOR COCOON, STEEL

CERTIFICATIONS:



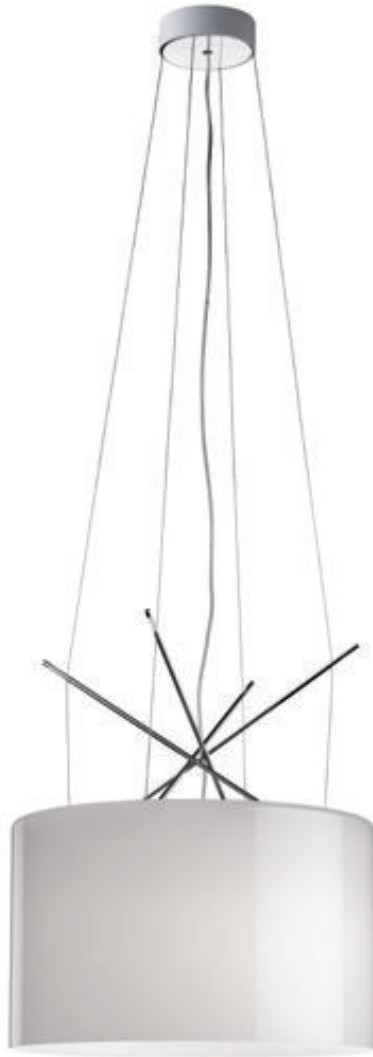

RAY S

DESIGN **RODOLFO DORDONI 2007**

LAMP: 1 x 250W T10 MEDIUM BASE

8,38 (lbs.) METAL

● FU593530 ○ FU593509 ● FU593420

14,90 (lbs.) GLASS

CONSTRUCTION MATERIALS:
STEEL, ALUMINUM, GLASS

CERTIFICATIONS:

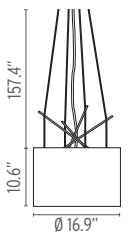



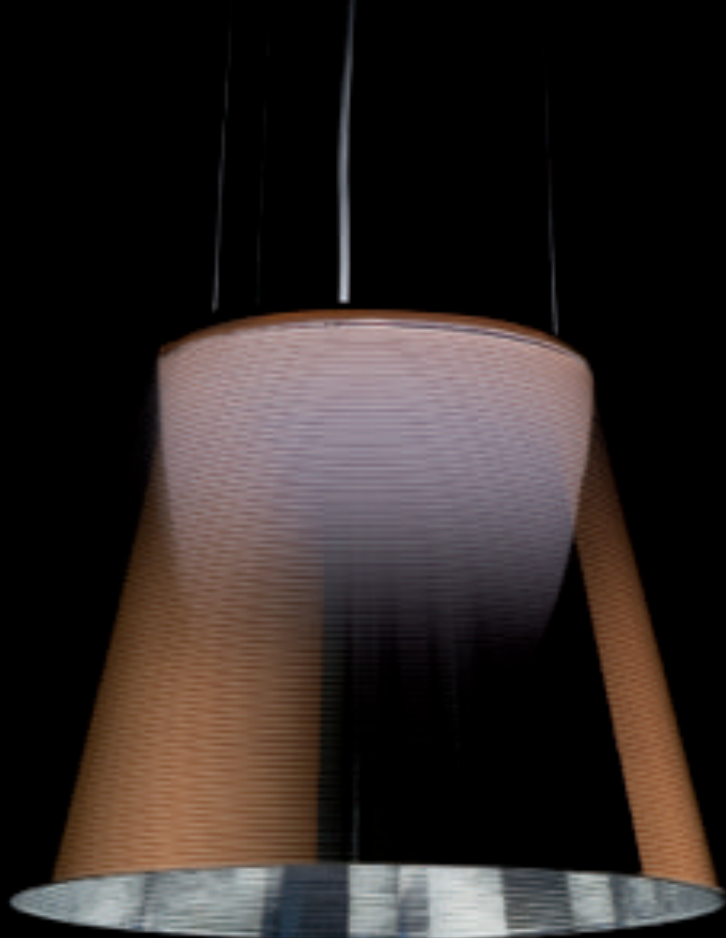
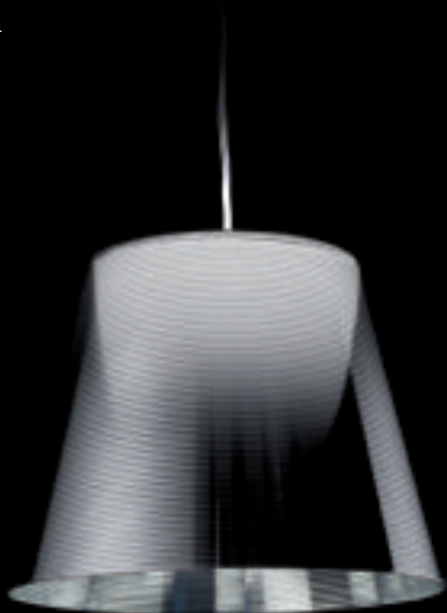

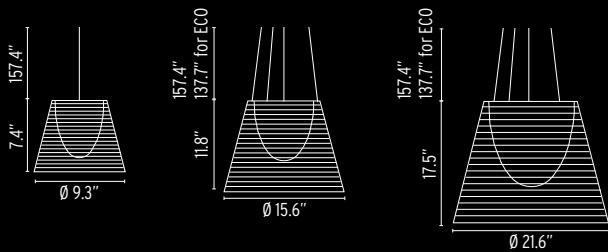

KTRIBE S

DESIGN PHILIPPE STARCK 2005

KTRIBE S1	LAMP: 1 X 75W T4 G9 FROSTED	2,2 (lbs.)
● FU625600	● FU625630	
KTRIBE S2	LAMP: 1 X 150W T10 MEDIUM BASE	5,5 (lbs.)
● FU625700A	● FU625700	● FU625730
● FU625746		
KTRIBE S2 ECO	LAMP: 1 X 26W G240-3	5,5 (lbs.)
● FU625400A	● FU625400	● FU625430
● FU625446		
KTRIBE S3	LAMP: 1 X 250W T10 MEDIUM BASE	9,2 (lbs.)
● FU625800A	● FU625800	● FU625830
● FU625846		
KTRIBE S3 ECO	LAMP: 1 X 42W G240-4	9,2 (lbs.)
● FU625900A	● FU625900	● FU625930
● FU625946		
CONSTRUCTION MATERIALS: POLYCARBONATE, POLYMETHYLMETHACRYLATE		CERTIFICATIONS: cUL 







PARENTESI

DESIGN **ACHILLE CASTIGLIONI AND PIO MANZÙ 1971**

LAMP: 1 x 120W BR40 MEDIUM BASE

7,94 (lbs.)

● FU540030 ◐ FU540058 ● FU540035

CONSTRUCTION MATERIALS:
STEEL, ELASTOMER

CERTIFICATIONS:

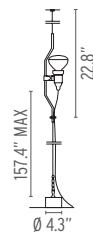





FUCSIA 1

DESIGN **ACHILLE CASTIGLIONI 1996**

LAMP: 1 x 40W E14 R50 REFLECTOR

2,2 (lbs.)

● FU241400 (CLEAR CORD) ● FU241000 (WHITE CORD)*

CONSTRUCTION MATERIALS:
GLASS, STEEL, SILICONE

CERTIFICATIONS:



192"

13,6"

Ø 6,3"







FUCSIA 3

DESIGN **ACHILLE CASTIGLIONI 1996**

LAMPS: 3 x 40W E14 R50 REFLECTOR

5,5 (lbs.)

● FU241500 (CLEAR CORD) ● FU241100 (WHITE CORD)*

CONSTRUCTION MATERIALS:
GLASS, STEEL, SILICONE

CERTIFICATIONS:

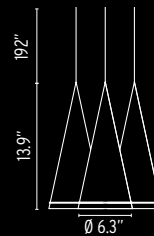
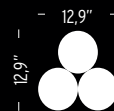

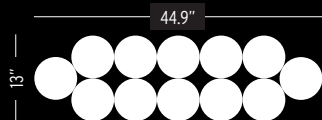
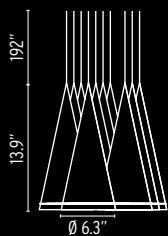

FUCSIA 12

DESIGN **ACHILLE CASTIGLIONI 1996**

LAMPS: 12 x 40W E14 R50 REFLECTOR

31.5 (lbs.)

● FU241700 (CLEAR CORD) ● FU241300 (WHITE CORD)*

CONSTRUCTION MATERIALS:
GLASS, STEEL, SILICONE

CERTIFICATIONS:
* c  



FUCSIA 8

DESIGN **ACHILLE CASTIGLIONI 1996**

LAMPS: 8 x 40W E14 R50 REFLECTOR

19,6 (lbs.)

● FU241600 (CLEAR CORD) ● FU241200 (WHITE CORD)*

CONSTRUCTION MATERIALS:
GLASS, STEEL, SILICONE

CERTIFICATIONS:

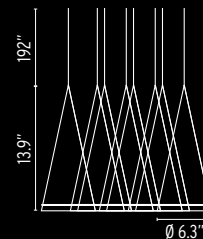
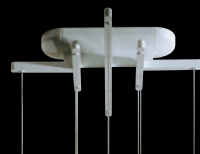
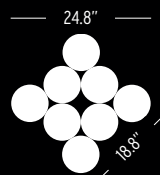





GLO-BALL S

DESIGN JASPER MORRISON 1998

GLO-BALL S1	LAMP: 1 x 100W T10 MEDIUM BASE	○ FU300561	5,95 (lbs.)
GLO-BALL S1 ECO	LAMP: 1 x 26W G240-3	○ FU300361	
GLO-BALL S2	LAMP: 1 x 150W T10 MEDIUM BASE	○ FU301061	12,35 (lbs.)
GLO-BALL S2 ECO	LAMP: 1 x 42W G240-3	○ FU301161	

CONSTRUCTION MATERIALS:
BLOWN GLASS, STEEL

CERTIFICATIONS:

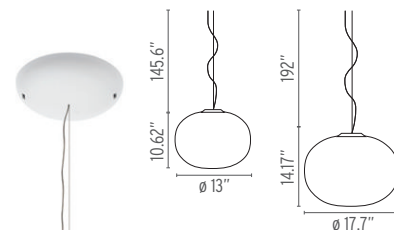





LASTRA 8 RECTANGULAR

DESIGN **ANTONIO CITTERIO** WITH **OLIVER LÖW** 1998

LAMPS: 8 x 35W MR11 GU4

57,32 (lbs.)

FU336200

CONSTRUCTION MATERIALS:
ALUMINUM, GLASS, POLYCARBONATE

CERTIFICATIONS:

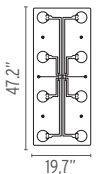

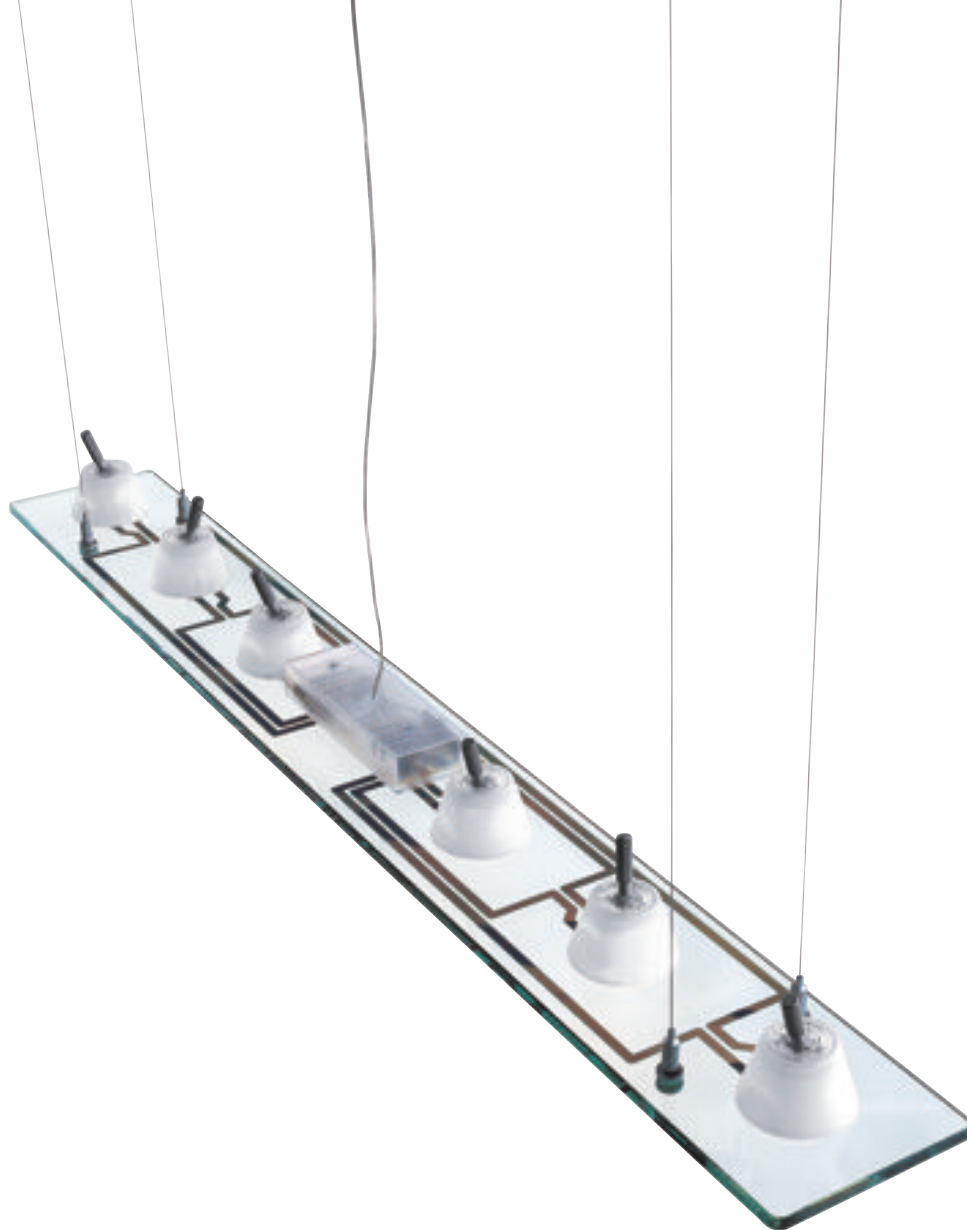

LASTRA 6

DESIGN **ANTONIO CITTERIO** WITH **OLIVER LÖW 1998**

LAMPS: 6 x 35W MR11 GU4

37,48 (lbs.)

FU336100

CONSTRUCTION MATERIALS:
ALUMINUM, GLASS, POLYCARBONATE

CERTIFICATIONS:









CICATRICES DE LUXE 3

DESIGN PHILIPPE STARCK 2000

LAMPS: 3 x 35W 12V T4 GY6.35 CLEAR

20.5 (lbs.) - H 31.4"

● FU165000 (H 31.4") ● FU164000 (H 43.3")

22 (lbs.) - H 43.3"

CONSTRUCTION MATERIALS:
BLOWN CRYSTAL, GLASS, STEEL

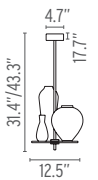





CICATRICES DE LUXE 5

DESIGN PHILIPPE STARCK 2000

LAMPS: 5 x 35W 12V T4 GY6.35 CLEAR

33 (lbs.) - H 31.4"

● FU165300 (H 31.4") ● FU164300 (H 43.3")

34 (lbs.) - H 43.3"

CONSTRUCTION MATERIALS:
BLOWN CRYSTAL, GLASS, STEEL

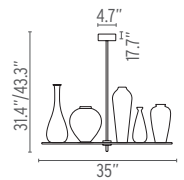

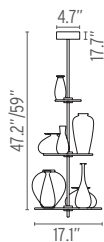

CICATRICES DE LUXE 8

DESIGN PHILIPPE STARCK 2000

LAMPS: 8 x 35W 12V T4 GY6.35 CLEAR

● FU165600 (H 47.2") ● FU164600 (H 59")

33 (lbs.) - H 47.2"

34 (lbs.) - H 59"

CONSTRUCTION MATERIALS:
BLOWN CRYSTAL, GLASS, STEEL

**BRERA S**DESIGN **ACHILLE CASTIGLIONI 1992**

LAMP: 1 x 100W A19 MEDIUM BASE

3,09 (lbs.)

○ FU141709

CONSTRUCTION MATERIALS:
GLASS, NYLON, POLYCARBONATE

CERTIFICATIONS:

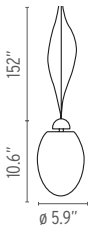



**FRISBI**DESIGN **ACHILLE CASTIGLIONI 1978**

LAMP: 1 x 100W K19

5,95 (lbs.)



● FU250000 ● FU250030

CONSTRUCTION MATERIALS:

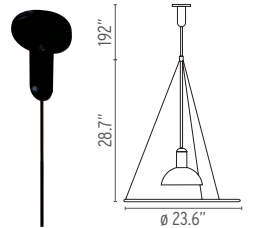
METAL, POLYMETHYLMETHACRYLATE, STEEL





SPLÜGEN BRÄU DESIGN ACHILLE AND PIER GIACOMO CASTIGLIONI 1961	
LAMP: 1 x MAX 100W A-21 IA/S	3.3 (lbs.)
 FU640000	
CONSTRUCTION MATERIALS: POLISHED ALUMINUM	CERTIFICATIONS: 



ROMEO LOUIS II

DESIGN PHILIPPE STARCK 2003

ROMEO LOUIS II 1 LAMP: 1 x 150W T10 MEDIUM BASE 8,6 (lbs.)

● FU644000

ROMEO LOUIS II 2 LAMP: 1 x 150W T10 MEDIUM BASE 15,4 (lbs.)

● FU644300

CONSTRUCTION MATERIALS:
CRYSTAL, GLASS, POLYCARBONATE

CERTIFICATIONS:

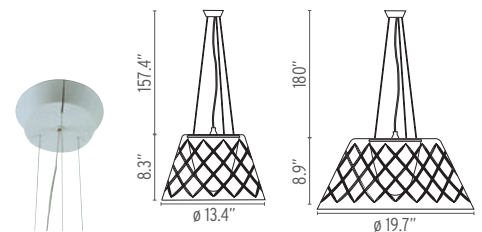





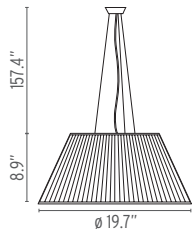
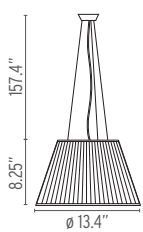

ROMEO MOON S

DESIGN PHILIPPE STARCK 1996

ROMEO MOON S1	LAMP: 1 x 100W A19	FU610500	9,9 (lbs.)
ROMEO MOON S1 ECO	LAMP: 1 x 18W G240-3	FU613100	
ROMEO MOON S2	LAMP: 1 x 150W A21 MEDIUM BASE	FU611000	16,7 (lbs.)
ROMEO MOON S2 ECO	LAMP: 1 x 26W G240-3	FU613200	

CONSTRUCTION MATERIALS:
GLASS, POLYCARBONATE

CERTIFICATIONS:





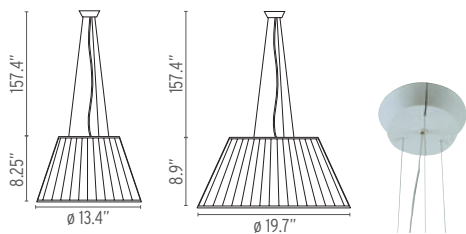



ROMEO SOFT S

DESIGN PHILIPPE STARCK 1996

ROMEO SOFT S1	LAMP: 1 x 100W A19	● FU610507	3,5 (lbs.)
ROMEO SOFT S1 ECO	LAMP: 1 x 18W G240-3	● FU609607	
ROMEO SOFT S2	LAMP: 1 x 150W A21 MEDIUM BASE	● FU611007	7,5 (lbs.)
ROMEO SOFT S2 ECO	LAMP: 1 x 26W G240-3	● FU609707	
CONSTRUCTION MATERIALS: FABRIC, GLASS			CERTIFICATIONS:  



2097

DESIGN GINO SARFATTI 1958

2097/30 LAMPS: 30 x 15W E14 - EURO BASE 11,2 (lbs.)

AU140057 AU140059

2097/50 LAMPS: 50 x 15W E14 - EURO BASE 20,2 (lbs.)

A1500057 A1500059

CONSTRUCTION MATERIALS:
BRASS, STEEL

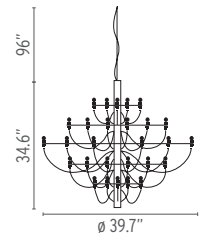
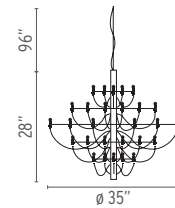



**TARAXACUM 88 S1**DESIGN **ACHILLE CASTIGLIONI 1988**

LAMPS: 60 x 25W G40 MEDIUM BASE CLEAR

23,4 (lbs.)

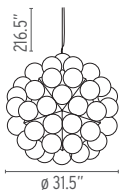
 FU743000CONSTRUCTION MATERIALS:
ALUMINUM



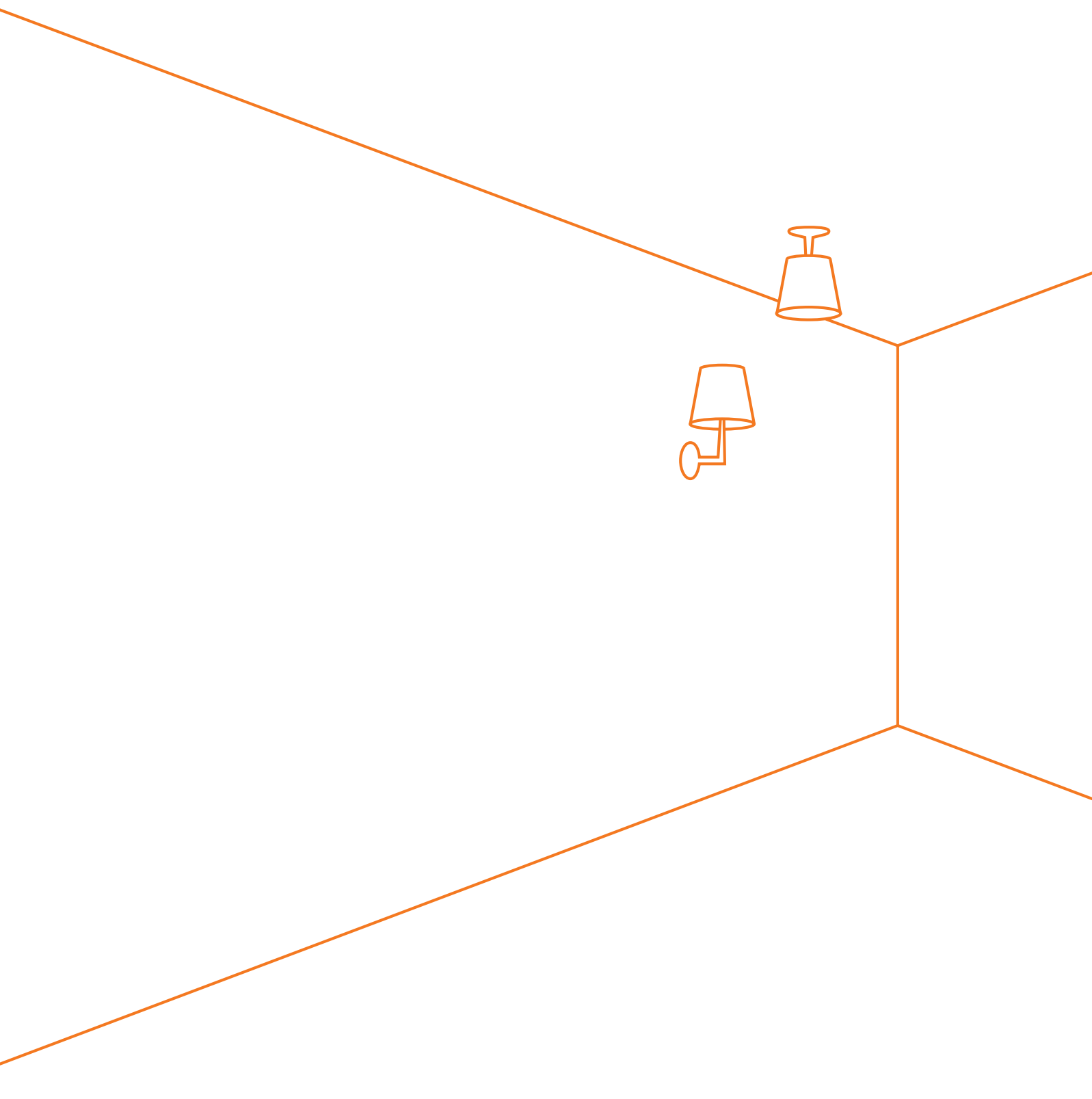

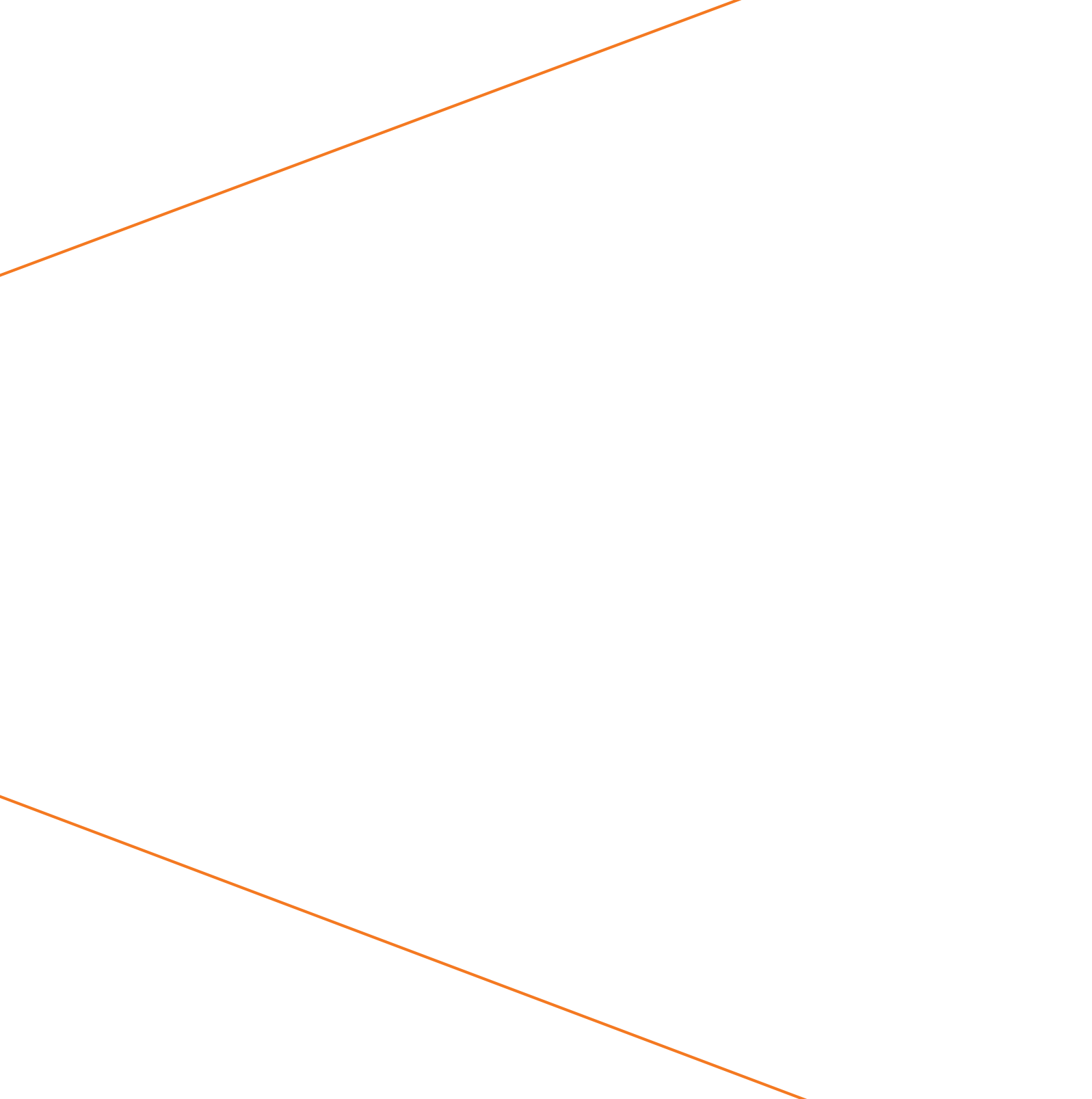

OROTUNDDESIGN **MARC NEWSON 2013****LAMP:** 120 TOP LED - 10W - 650LM - 2700K - CRI85

1,16 (lbs.)

 FU409009 FU409020 FU409038**CONSTRUCTION MATERIALS:**
ABS, POLYCARBONATE**CERTIFICATIONS:**

ø 9.60"









236



HIDE S - HIDE L

DESIGN PHILIPPE STARCK 2011

HIDE S	LAMP: FLAT PANEL 3000K 656lm CRI80 - 10W	1,10 (lbs.)
○ FU002009 ● FU002030 ○ F0023000 ● F0023054 ● F0023046 ● F0023068		
HIDE L	LAMP: FLAT PANEL 3000K 1800lm CRI80 - 25W	3,74 (lbs.)
○ FU002109 ● FU002130 ○ F0022000 ● F0022054 ● F0022046 ● F0022068		
CONSTRUCTION MATERIALS: ALUMINUM, PMMA		CERTIFICATIONS: c  

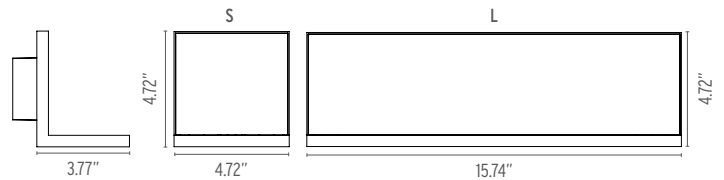











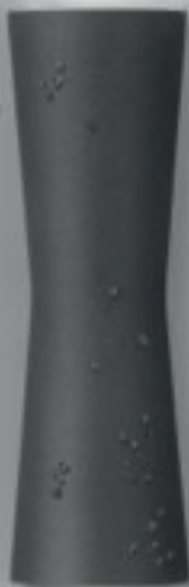



CLESSIDRA

DESIGN ANTONIO CITTERIO 2011

LAMP: 2 MULTICHIP LED 3000K 600lm CRI 80 - 10W

2,42 (lbs.)

● FU158357 (20°+20°) FU158457 (40°+40°) ○ FU158309 (20°+20°) FU158409 (40°+40°)

CONSTRUCTION MATERIALS:
ALUMINUM, PMMA

CERTIFICATIONS:











248



TIGHT LIGHT

DESIGN **PIERO LISSONI 2011**

LAMP: 48 TOP LED 3000K 1460lm total CRI80 - 2X9W

2.49 (lbs.)

○ FU001709

CONSTRUCTION MATERIALS:
ALUMINUM, PMMA

CERTIFICATIONS:

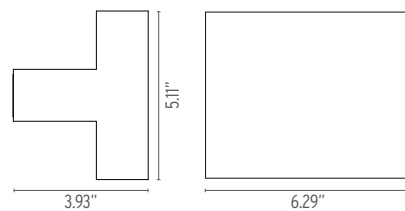





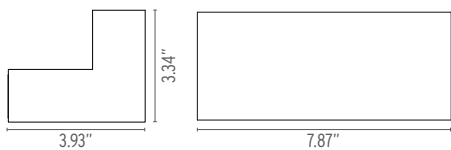
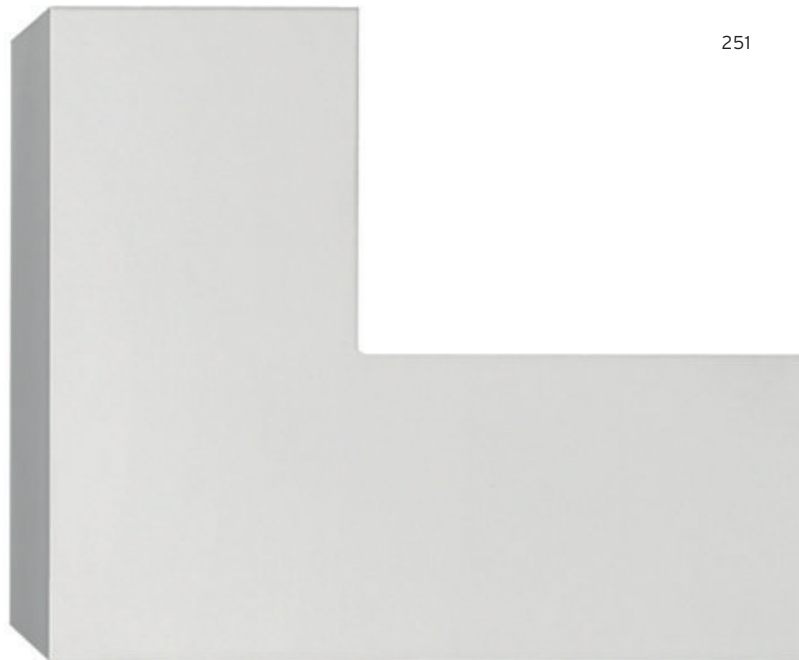

LONG LIGHT

DESIGN PIERO LISSONI 2011

LAMP: 28 TOP LED 3000K 854lm total CRI80 - 12W

2,42 (lbs.)

○ FU001609

CONSTRUCTION MATERIALS:
ALUMINUM, PMMA

CERTIFICATIONS:





LIGHTSPRING

DESIGN RON GILAD 2011

LIGHT SPRING SINGLE	LAMPS: 14 TOP LED 3000K 320lm total - CRI80 - 4,5W	1,32 (lbs.)
---------------------	--	-------------

○ FU334309

LIGHT SPRING DOUBLE	LAMPS: 2x14 TOP LED 3000K 2X320lm total - CRI80 - 9W	2,64 (lbs.)
---------------------	--	-------------

○ FU334409

CONSTRUCTION MATERIALS:
METHACRYLATE, ALUMINUM

CERTIFICATIONS:

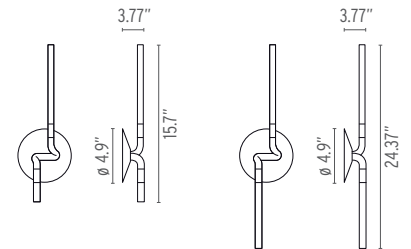

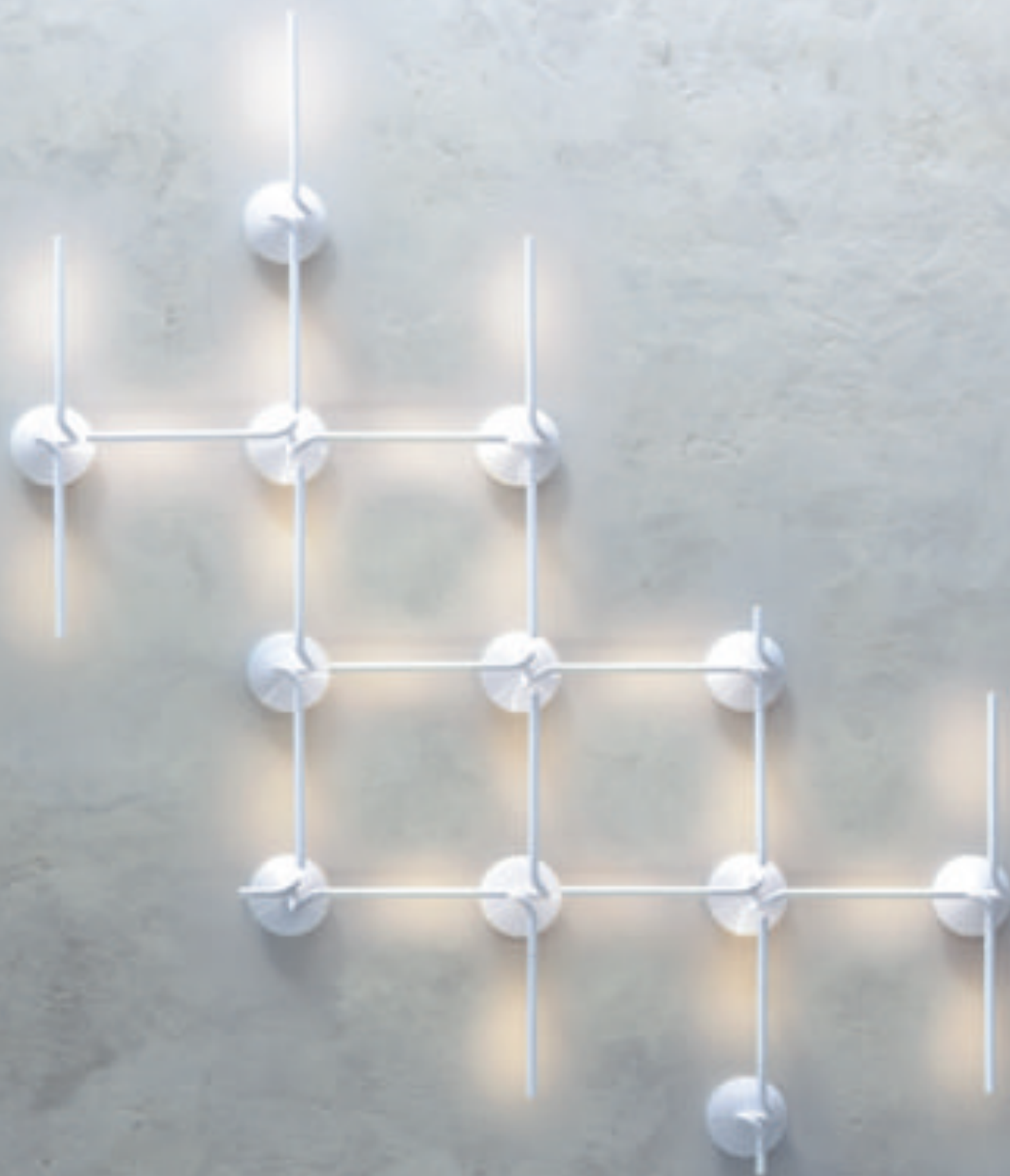



TAU

DESIGN **RODOLFO DORDONI 2009**

LAMP: 1 x 100W R7 HALOGEN

2,2 (lbs.)

WHITE BODY  FU654109 BLACK BODY  FU654130 CHROME BODY  FU654157

CONSTRUCTION MATERIALS:
ALUMINUM

CERTIFICATIONS:

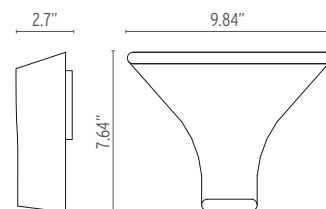







SMITHFIELD C

DESIGN JASPER MORRISON 2009

SMITHFIELD C	LAMP: 1 x 200W T3 R7S CLEAR	11 (lbs.)
● FU136230 ○ FU136209 ● FU136221		
SMITHFIELD C ECO	LAMPS: 3 x 24W 2G11	
● FU136330 ○ FU136309 ● FU136321		
CONSTRUCTION MATERIALS: ALUMINUM, POLYCARBONATE		CERTIFICATIONS:  

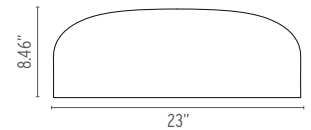





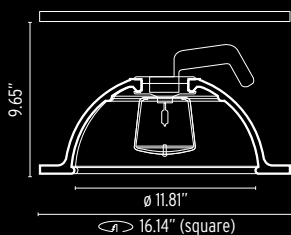
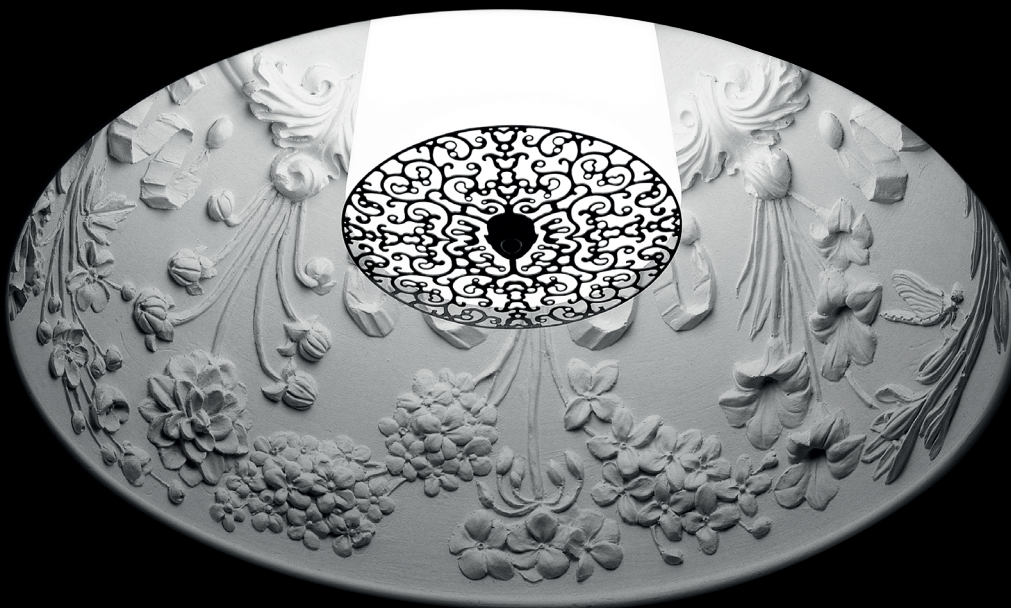

SKYGARDEN RECESSED

DESIGN MARCEL WANDERS 2009

LAMP: 1 x 50W T4 GY6.35

● FU643009

8,82 (lbs.)

LAMP: 1 x 60W T4 G9 FROSTED

● FU643309

CONSTRUCTION MATERIALS:
PLASTER, GLASS, STAINLESS STEEL

CERTIFICATIONS:





FOGLIO

DESIGN **TOBIA SCARPA 1966**

LAMPS: 2 x 100W A19 MEDIUM BASE

8.16 (lbs.)

○ FU240009 ● FU240057

CONSTRUCTION MATERIALS:
STEEL

CERTIFICATIONS:

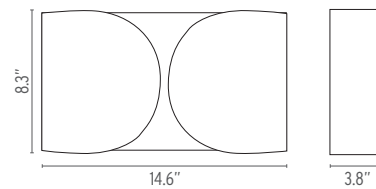



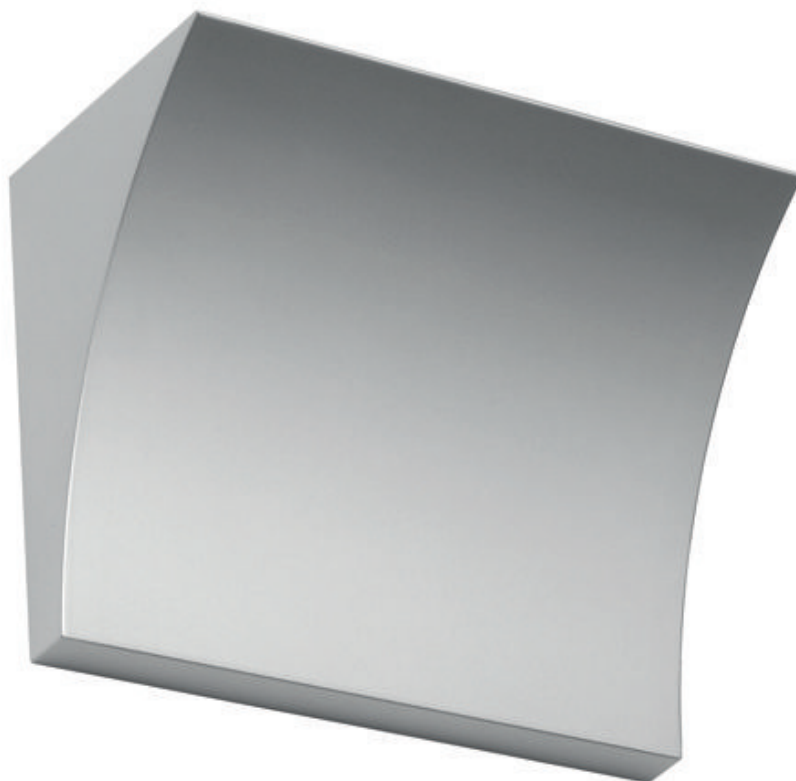

POCHETTE

DESIGN **RODOLFO DORDONI 2003**

LAMP: 1 X 200W T3 R7S CLEAR

3,5 (lbs.)

● FU970020 ■ FU970057

CONSTRUCTION MATERIALS:
GLASS, STEEL, ZAMAK

CERTIFICATIONS:

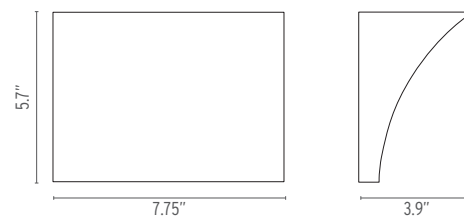



TILEE

DESIGN MARCELLO ZILIANI 2005

LAMP: 1 x 60W T4 G9 FROSTED

1,76 (lbs.)

FU746009

CONSTRUCTION MATERIALS:
GLASS, ZAMAK

CERTIFICATIONS:

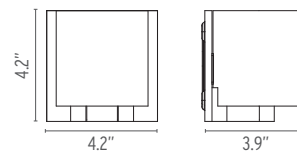



MINI BUTTON

DESIGN PIERO LISSONI 2005

LAMPS: 1 x 25W G9 FROSTED HALOGEN

1,3 (lbs.)

 FU149009

CONSTRUCTION MATERIALS:
ALUMINUM, GLASS, POLYCARBONATE, STEEL

CERTIFICATIONS:



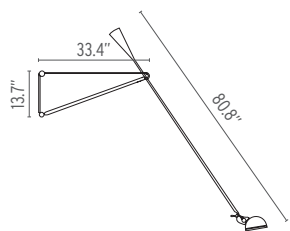



265
DESIGN PAOLO RIZZATTO 1973

LAMP: 1 x 75W A19 MEDIUM BASE	13,23 (lbs.)	
<input checked="" type="radio"/> AU030030	<input type="radio"/> AU030020	<input type="radio"/> AU030009
CONSTRUCTION MATERIALS: STEEL		



ONTHEROCKS HL

DESIGN **ANTONIO CITTERIO** WITH **TOAN NGUYEN** 2004

LAMP: 1 X 200W T3 R7S CLEAR

5.5 (lbs.)

FU465100

CONSTRUCTION MATERIALS:
GLASS

CERTIFICATIONS:

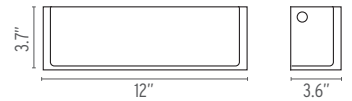



270



MINI GLO-BALL C/W

DESIGN JASPER MORRISON 2002

LAMP: 1 x 25W T4 G9 FROSTED

0,66 (lbs.)

● FU419009

CONSTRUCTION MATERIALS:
GLASS

CERTIFICATIONS:

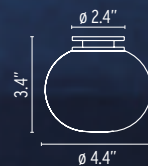

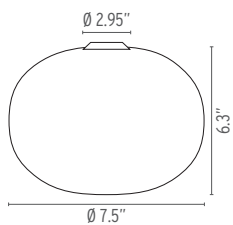

GLO-BALL C/W ZERO

DESIGN JASPER MORRISON 2009

LAMP: 1 x 40W G9 T4

2.2 (lbs.)

○ FU333509

CONSTRUCTION MATERIALS:
GLASS



CERTIFICATIONS:





GLO-BALL C

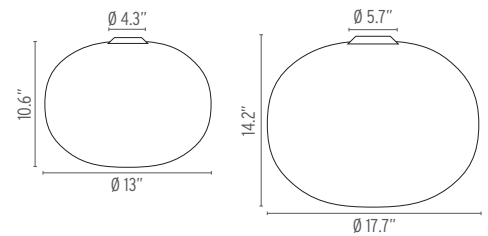

DESIGN JASPER MORRISON 1998/1999

GLO-BALL C1	LAMP: 1 x 100W T10 MEDIUM BASE	○ FU302300	5,5 (lbs.)
GLO-BALL C2	LAMP: 1 x 150W T10 MEDIUM BASE	○ FU302800	11,25 (lbs.)
CONSTRUCTION MATERIALS: GLASS			CERTIFICATIONS:  



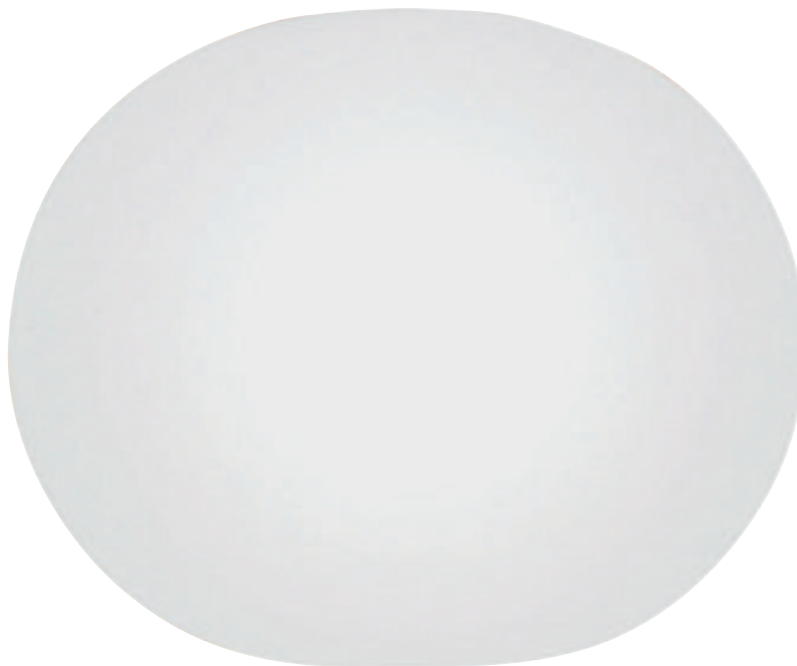



GLO-BALL W DESIGN JASPER MORRISON 1999	
LAMP: 1 x 100W T8 E26 MEDIUM BASE	3,97 (lbs.)
○ FU302200	
CONSTRUCTION MATERIALS: GLASS	CERTIFICATIONS:  

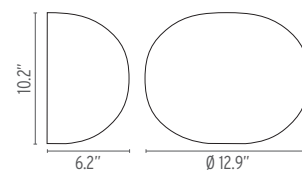



ARIETTE

DESIGN **TOBIA SCARPA 1973**

ARIETTE 1	 FU040009	1,76 (lbs.)
ARIETTE 2	 FU050009	2,20 (lbs.)
ARIETTE 3	 FU060009	2,42 (lbs.)

LAMPS: 4 x 40W A19 MEDIUM BASE

CONSTRUCTION MATERIALS:
FABRIC

31.5" (1) / 39.3" (2) / 51.2" (3)







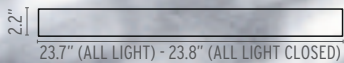

ALL LIGHT

DESIGN RODOLFO DORDONI 2002

ALL LIGHT	LAMP: 1 x 24W T5 FL (ELECTRONIC BALLAST)	2,65 (lbs.)
● FU018071		
ALL LIGHT CLOSED	LAMP: 1 x 24W T5 FL (ELECTRONIC BALLAST)	4,20 (lbs.)
● FU018209	● FU018257	● FU018256

CONSTRUCTION MATERIALS:
POLYCARBONATE (ALL LIGHT) - POLYCARBONATE, STEEL (ALL LIGHT CLOSED)

CERTIFICATIONS:



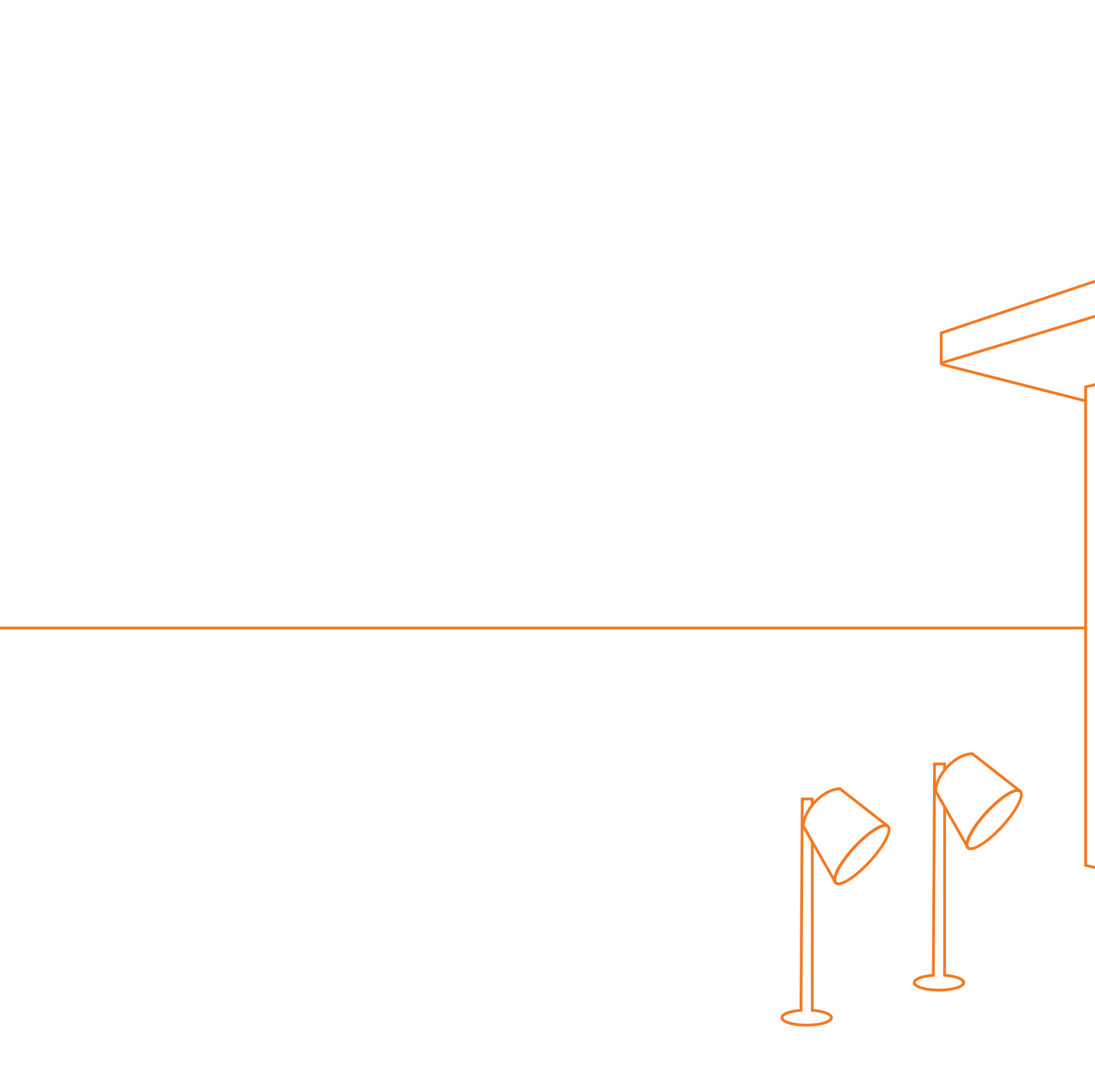

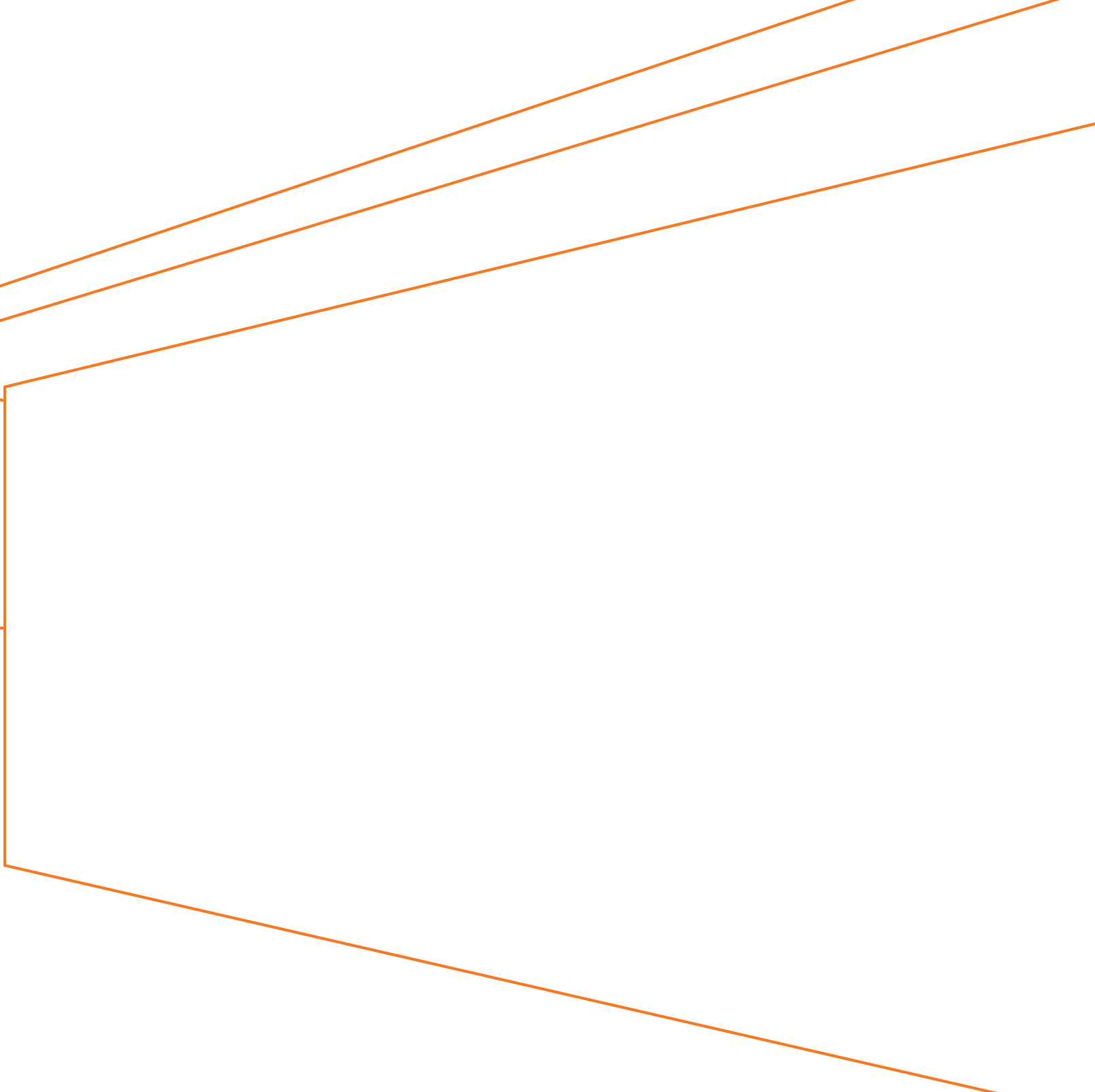







BELVEDERE

DESIGN
ANTONIO CITTERIO WITH TOAN NGUYEN

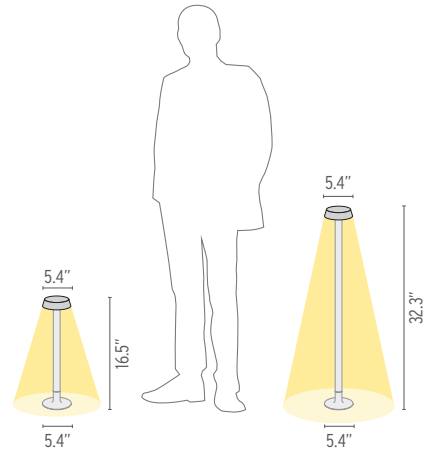
CONSTRUCTION MATERIALS:
ALUMINUM PAINTED WITH ANTI-CORROSIIVE PIGMENTS



CLOVE 1
POWER LED
350 MA
6 X 1W
4000K

● FU094026

CLOVE 2
POWER LED
350 MA
6 X 1W
4000K

● FU094226

**INSTALLATION
ACCESSORY**





F0888026
Remote housing

BELVEDERE CLOVE

DESIGN
ANTONIO CITTERIO WITH TOAN NGUYEN 2007

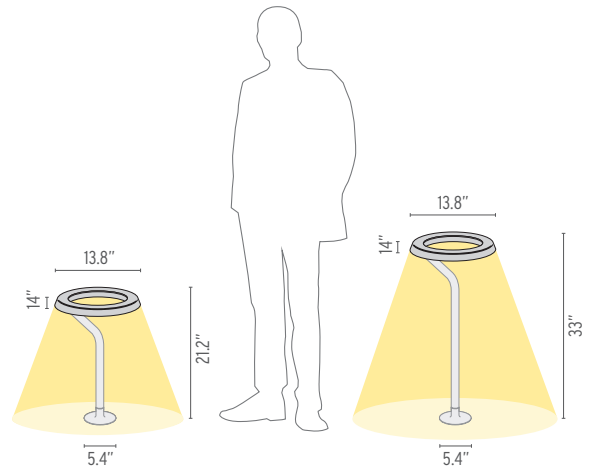
CONSTRUCTION MATERIALS:
ALUMINUM PAINTED WITH ANTI-CORROSIVE PIGMENTS



ROUND 1
POWER LED
350 MA
10 X 1W
4000K

 FU094426

ROUND 2
POWER LED
350 MA
10 X 1W
4000K

 FU094626

**INSTALLATION
ACCESSORY**



F0888026
Remote housing



BELVEDERE ROUND

DESIGN
ANTONIO CITTERIO WITH TOAN NGUYEN 2009

CONSTRUCTION MATERIALS:
ALUMINUM PAINTED WITH ANTI-CORROSIVE PIGMENTS



BELVEDERE SPOT F

DESIGN
ANTONIO CITTERIO WITH TOAN NGUYEN 2007

CONSTRUCTION MATERIALS:
ALUMINUM PAINTED WITH ANTI-CORROSIVE PIGMENTS



SPOT F1



SPOT F2 SINGLE



SPOT F2 DOUBLE



SPOT F3 SINGLE



SPOT F3 DOUBLE



POWER LED
350 MA
6 X 1W
4000K

- FU091126 - 6 X 1W 9°
- FU091226 - 6 X 1W 22°
- FU091326 - 6 X 1W 36°

- FU089726 - 6 X 1W 9°
- FU089826 - 6 X 1W 22°
- FU089926 - 6 X 1W 36°

- FU090426 - 6 X 1W 9°
- FU090526 - 6 X 1W 22°
- FU090626 - 6 X 1W 36°

- FU090126 - 6 X 1W 9°
- FU090226 - 6 X 1W 22°
- FU090326 - 6 X 1W 36°

- FU090726 - 6 X 1W 9°
- FU090826 - 6 X 1W 22°
- FU090926 - 6 X 1W 36°

REMOTE
PHOSPHOR LED
1 X 11.8W
38°
3000K

- FU093026

- FU093226

- FU093626

- FU093426

- FU093826

INSTALLATION
ACCESSORY



F0888026
Remote housing







45

DESIGN
TIM DERHAAG

CONSTRUCTION MATERIALS:
DIE-CAST ALUMINUM

45 ADJ LED 1

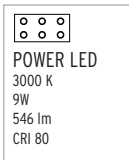

- F0070000
- F0070054
- F0070030

45 ADJ LED 2

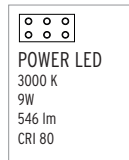
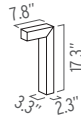

- F0071000
- F0071054
- F0071030

45 ADJ LED 3

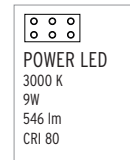
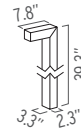
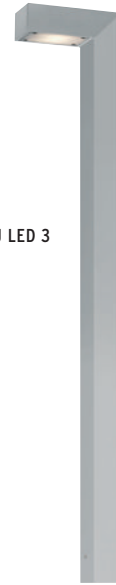

- F0072000
- F0072054
- F0072030

ACCESSORIES



F0074071
High comfort diffuser



F0074000
High performance diffuser



F0056030
Low light grid



F0058000
Flange to be cemented



F0057000
Pole to be placed in the ground



F0059000
Kit of maintenance for teak





296

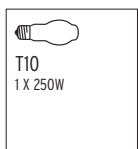

- FU636722
- FU636741

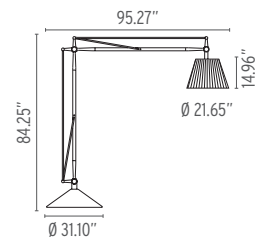



SUPERARCHIMON OUTDOOR

DESIGN
PHILIPPE STARCK 2004

CONSTRUCTION MATERIALS:
ALUMINIUM, SPECIAL MATERIALS FOR GOOD WEATHER RESISTANCE

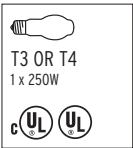

- FU626822
- FU626841

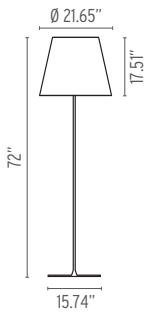



KTRIBE F3 OUTDOOR

DESIGN
PHILIPPE STARCK 2010

CONSTRUCTION MATERIALS:
DIE-CAST ALUMINUM BASE, PVC TUBES, STEEL



ROMEO OUTDOOR

DESIGN
PHILIPPE STARCK 2006

CONSTRUCTION MATERIALS:
DIE-CAST ALUMINUM, POLYCARBONATE, STAINLESS STEEL



W1 PVC



C1 PVC



W1 GRI

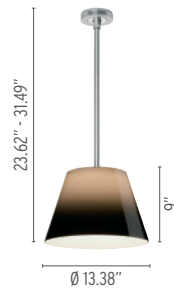

C1 GRI



C3 PVC



BT 15
1 X 72W

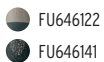

FU646122

FU646141

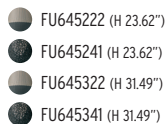

FU645222 (H 23.62")

FU645241 (H 23.62")

FU645322 (H 31.49")

FU645341 (H 31.49")



FU646120

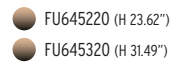

FU645220 (H 23.62")

FU645320 (H 31.49")



T10
1 X 150W

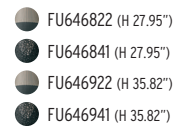

FU646822 (H 27.95")

FU646841 (H 27.95")

FU646922 (H 35.82")

FU646941 (H 35.82")





2 X MULTICHIP LED
3000 K
10W
600lm
CRI 80



- FU158326 (20°+20°)
- FU158426 (40°+40°)
- FU158323 (20°+20°)
- FU158423 (40°+40°)

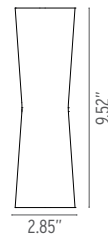



CLESSIDRA

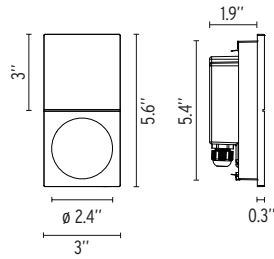

DESIGN
ANTONIO CITTERIO 2011

CONSTRUCTION MATERIALS:
ALUMINUM, PMMA

306



POWER LED
210 lm
2.2W
3000K
CRI80

-  09.3310.01.9S
-  09.3310.72.9S
-  09.3310.04.9S



 **01.9S**
MATT WHITE



 **72.9S**
GREY



 **04.9S**
MATT BLACK





THEBLOCKOFLIGHT

DESIGN
KNUD HOLSCHER

CONSTRUCTION MATERIALS:
ALUMINUM

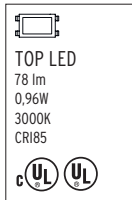

- | | | |
|-----------------|-----------------|-----------------|
| WHITE LIGHT | AMBER LIGHT | BLUE LIGHT |
| ○ 09.3200.30.9S | ○ 09.3201.30.9S | ○ 09.3202.30.9S |
| ● 09.3200.29.9S | ● 09.3201.29.9S | ● 09.3202.29.9S |
| ● 09.3200.AN.9S | ● 09.3201.AN.9S | ● 09.3202.AN.9S |
| 09.3200.55.9S | 09.3201.55.9S | 09.3202.55.9S |
| ● 09.3200.BZ.9S | ● 09.3201.BZ.9S | ● 09.3202.BZ.9S |

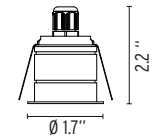
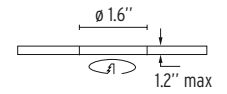

- | | | | | |
|------------------|----------------------------------|------------------------------|-----------------------------|-------------------|
| | | | | |
| ○ 30.9S
WHITE | ● 29.9S
ANODIZED
ALUMINIUM | ● AN.9S
ANODIZED
BLACK | 55.9S
STAINLESS
STEEL | ● BZ.9S
BRONZE |

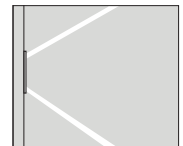



G-0

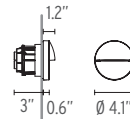
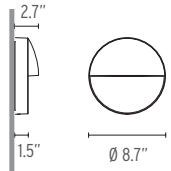
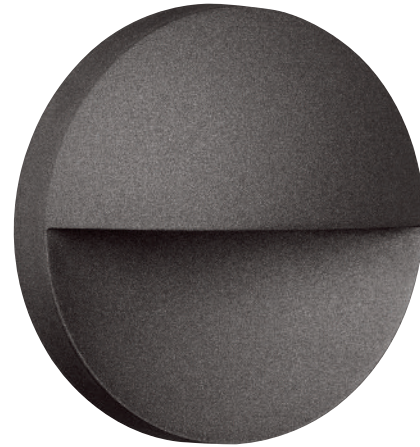
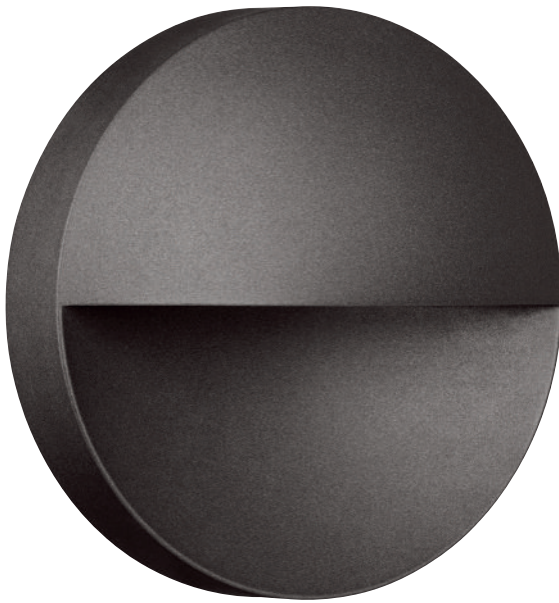

DESIGN
JORGE HERRERA

CONSTRUCTION MATERIALS:
ALUMINUM

310



POWER LED
 450lm
 6W



POWER LED
 117lm
 1W

- 09.3001.01.9S
- 09.3001.72.9S
- 09.3001.04.9S
- 09.3001.MM.9S

- 09.3000.01.9S
- 09.3000.72.9S
- 09.3000.04.9S
- 09.3000.MM.9S



○ **01.9S**
MATT WHITE



● **72.9S**
GREY



● **04.9S**
MATT BLACK



● **MM.9S**
DARK BROWN





GIANO

DESIGN
RODOLFO DORDONI

CONSTRUCTION MATERIALS:
DIE-CAST ALUMINUM





WALLFLOWER

DESIGN
MARCEL WANDERS 2009

CONSTRUCTION MATERIALS:
ALUMINUM, GLASS

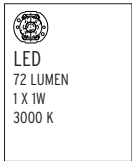
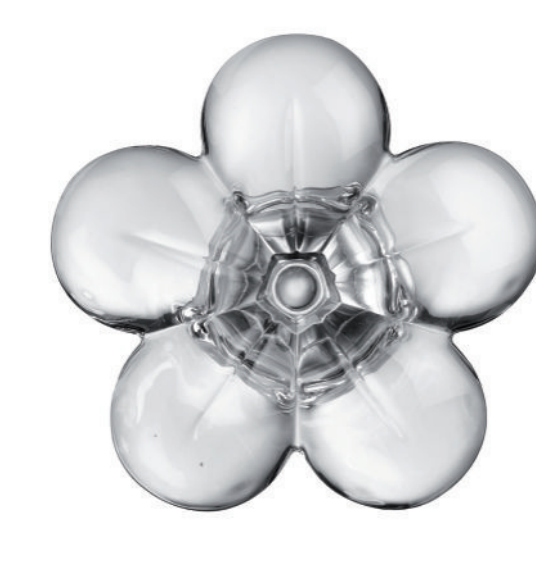

○ F9450061

● F9450000

APPLICATIONS

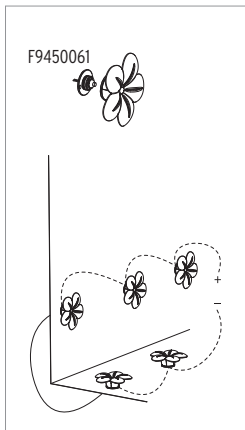

350 mA remote power prepared equipment

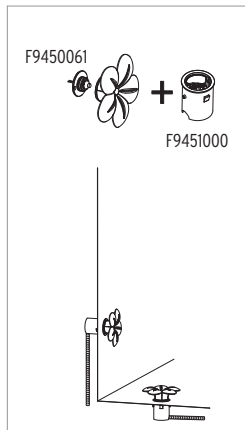

Remote housing + integrated power supply driver

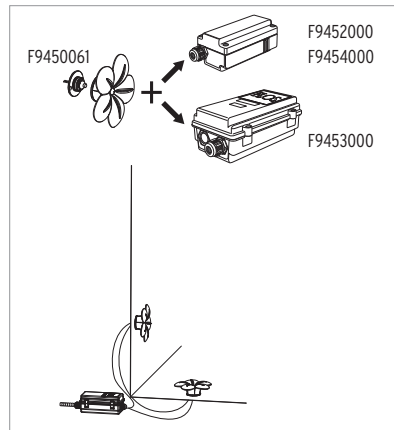



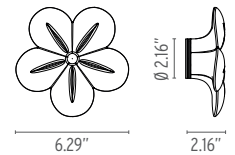

Junction box without remote housing, for wall/ground fittings with remote power









HSGS
G9
1 x 25W
FROSTED HALOGEN

● FU149009

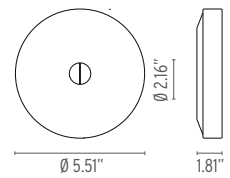



MINIBUTTON



DESIGN
PIERO LISSONI 2005

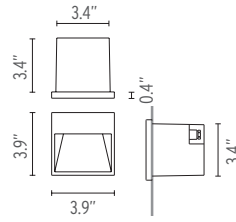
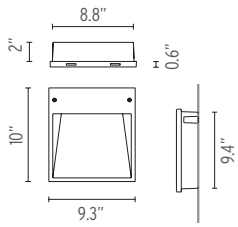
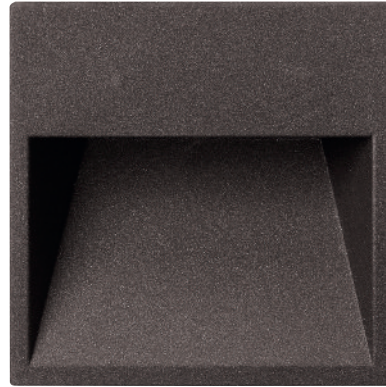



CONSTRUCTION MATERIALS:
GLASS





318



POWER LED
 450lm
 6W



POWER LED
 150lm
 2W

-  07.9007.01.90
-  07.9007.72.90
-  07.9007.04.90
-  07.9007.MM.90

-  07.9006.01.9S
-  07.9006.72.9S
-  07.9006.04.9S
-  07.9006.MM.9S



 **01.90/9S**
MATT WHITE

 **72.90/9S**
GREY

 **04.90/9S**
MATT BLACK

 **MM.90/9S**
DARK BROWN



**BOX
MINI BOX**

DESIGN
PIERO LISSONI

CONSTRUCTION MATERIALS:
DIE-CAST ALUMINUM

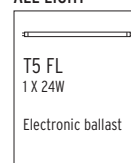
**ALL LIGHT**

● FU018071

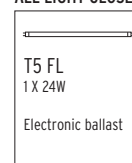
ALL LIGHT CLOSED

● FU018256



2.2"
23.7" (ALL LIGHT) - 23.8" (ALL LIGHT CLOSED)

3.1"

ALL LIGHT

DESIGN
RODOLFO DORDONI 2002

CONSTRUCTION MATERIALS:
POLYCARBONATE, STEEL

HEADQUARTERS

ITALY

Flos Spa
Via Angelo Faini, 2
25073 Bovezzo (Brescia)
Tel +39 0302438.1
Fax +39 0302438.250
info@flos.com

SPAIN

Antares Iluminación s.a.
Calle Mallorca, 1
Polígono Industrial Reva
46394 Ribarroja (Valencia)
Tel +34 96 166 95 20
Fax +34 96 166 82 86
flos.architectural@flos.com

BELGIUM and LUXEMBOURG

Flos Belux
M +32 474 413 485
Fax +39 0302438.250
flosbelux@flos.com

FRANCE

Flos S.A.R.L.
15/17 avenue de Ségur
75007 Paris
Tel +33 (0) 1 53 59 58 88
Fax +33 (0) 1 53 59 58 89
flos@flos.fr

GERMANY

Flos Spa
Tel +49 217310 93721
Fax +39 0302438.250
info@flos.com

UNITED KINGDOM

Atrium Ltd
28 Leonard Street
EC2A 4BY London
Tel +44 (0)20 7681 9933
Fax +44 (0)20 7681 9943
flos@atrium.ltd.uk

DENMARK

Flos Scandinavia A/S
Sydhavnsgade 28
DK-2450 København SV
Tel +45 (0) 3388 60 00
Fax +45 (0) 3388 60 10
info@flos.dk

NORWAY

Flos Norge A/S
SjølystPlass 4
N-0278 Oslo
Tel +47 (0) 2212 86 00
Fax +47 (0) 2212 86 08
info@flos.no

THE NETHERLANDS

Flos BV
Cruquiusweg 109Q
1019 AG Amsterdam
Tel +31 (0) 20 560 50 60
Fax +31 (0) 20 560 50 70
info@flosmail.nl

U. S. A.

Flos USA Inc.
110 York Street - 5th Floor
Brooklyn, NY 11201
Tel +1 (718) 875-3472
Fax +1 (718) 875-3473
info@flosusa.com

JAPAN

Flos Co., Ltd.
PMC Building 9F
1-23-5 Higashiazabu Minato-Ku
Tokyo 104-0044
Tel +81 (0) 3 35 82 14 68
Fax +81 (0) 3 35 82 09 74
info@flosjapan.com

FAR EAST

Flos Representative Office
1, Commonwealth Lane #08-12
149544 Singapore
Tel +65 (0) 6372 1495
Fax +65 (0) 6372 7607
flosasia@flos.com

CHINA

Flos China
Unit 827,8th Fl. - Intl Finance Centre
Tower2, 8th Century Ave.
Pudong District
Shanghai 200120 - China
Tel +86 21 6062 7197
Fax +86 21 6062 7169
floschina@flos.com

SHOWROOMS

MILANO

Corso Monforte, 15
20122 Milano
Tel +39 02 79 84 57
Fax +39 02 89 78 56 41
contract.milano@flos.com

COPENAGHEN

Sydhavnsgade 28
DK-2450 København SV
Tel +45 (0) 3388 60 00
Fax +45 (0) 3388 60 10
info@flos.dk

AMSTERDAM

Cruquiusweg 109Q
1019 AG Amsterdam
The Netherlands
Tel +31 (0) 20 560 50 60
Fax +31 (0) 20 560 50 70
info@flosmail.nl

TOKYO

PMC Building 9F
1-23-5 Higashiazabu Minato-Ku
Tokyo 104-0044
Tel +81 (0) 3 35 82 14 68
Fax +81 (0) 3 55 75 70 87
info@flosjapan.com

MADRID

C/Josè Silva 3 Bajos
28043 Madrid
Tel +34 916525372
showroom.madrid@flos.com

OSLO

Sjølyst Plass 4
N-0278 Oslo
Tel +47 (0) 2212 86 00
Fax +47 (0) 2212 86 08
info@flos.no

FLAGSHIP STORES

MILANO

Corso Monforte, 9
20122 Milano
Tel +39 02 37011080
Fax +39 02 37011081
flosmilano@flos.com

PARIS

15, rue de Bourgogne
75007 Paris
Tel +33 (0)1 53 85 49 93
Fax +33 (0)1 53 85 49 99
shop@flos.fr

HONG KONG

G/F Wyndham Place,
44 Wyndham Street, Central
Hong Kong
Tel +852 2801 7608
Fax +852 2869 0722
dentropo@netvigator.com

STOCKHOLM

Karlaplan
Lützengatan 1
S-115-20 Stockholm
Tel +46 (0) 8 660 4405
Fax +46 (0) 8 660 7005
info@flos.se

ROMA

Via del Babuino, 85
00187 Roma
Tel +39 06 3207631
Fax +39 06 3207690
flosroma@flos.com

LYON

17 rue Jarente
69002 LYON
Tel +33 478621301
Fax +33 478622119
lyon@flos.fr

LONDON

7-15 Rosebery Avenue
EC1R 4SP London
Tel +44 (0)203 328 51 40
flosuk@flos.com

NEW YORK

**152 Greene Street,
New York, NY 10012
Tel +1 212 941 4760
Fax +1 212 941 4763
soho@flosusa.com**

PHOTOGRAPHY:

JEAN-BAPTISTE MONDINO
SANTI CALECA
TOMMASO SARTORI
RAMAK FAZEL
GERMANO BORRELLI
DARIO PIACENTINI

STYLISTS:

GABRIELLA ZECCA
RAVAIOLI - SILENZI

PHOTO PRODUCT:

PIERO FASANOTTO

EDITION APRIL 2014

FLOS USA RESERVES THE RIGHT TO INTRODUCE ANY CHANGES TO ITS OWN MODELS, WITHOUT PRIOR NOTICE.