

**BOVER USA**





Els que vivim prop de la Mediterrània,  
coneixem tots els matisos de la llum.  
Per això en arribar la nit la  
transformem en petits espais de dia.

Lluís Porqueras

Los que vivimos cerca del Mediterráneo conocemos todos los matices de la luz.  
Por eso cuando llega la noche la transformamos en pequeños espacios de día.

Wir, die in der Nähe des Mittelmeers leben, kennen alle Abstufungen des Lichts.  
Wenn die Nacht kommt, verwandeln sie in kleine Punkte des Lichts.

Those of us who live near the Mediterranean know all the nuances of light.  
For this reason, when night comes, we transform it into little spacelets of day.

Mediterraneotik gertu bizi garenok ondo ezogutzen ditugu argiaren nabardura guztiak.  
Horregatik, goua datorrenean egun bihurtzen dugu gure argi-gune txikien bitartez.

Ceux qui, comme nous, habitent près de la Méditerranée connaissent toutes les nuances de la lumière.  
C'est pourquoi à la nuit tombée, nous la transformons en petits espaces de lumière.

Os que vivimos à beira do Mediterráneo conocemos todos los matices da luz.  
Por isso ao chegar a noite transformá-mos-la em pequenos espaços do día.

Noi che viviamo vicino al Mediterraneo conosciamo tutte le tonalità e le sfumature della luce.  
Per questo quando cala la notte, la trasformiamo in piccoli spazi del giorno.

Quem vive perto do Mediterráneo conhece todas as nuances da luz.  
Por isso, quando chega a noite, transformamo-la em pequenos espaços de día.

# BOVER USA

*GENERAL CATALOGUE*



# MADEINB



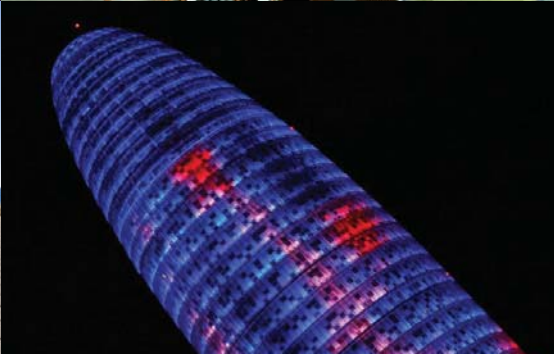
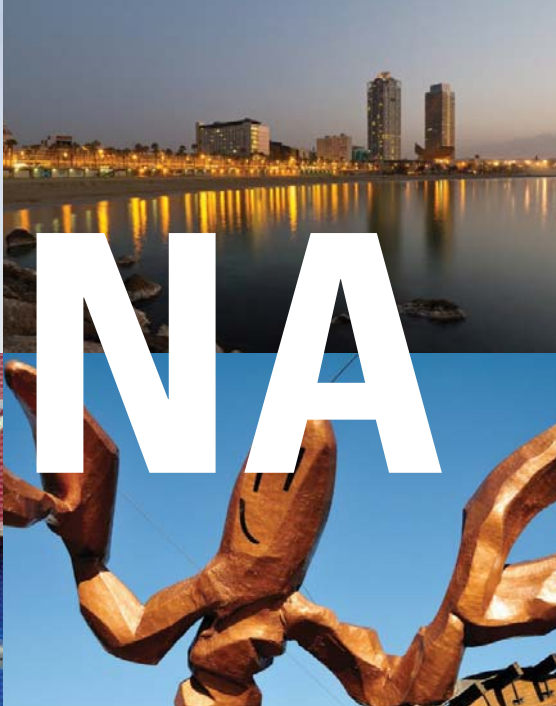

# BARCELONA



**OUTDOOR**

PAG 11



AMPHORA, 12  
FORA, 18  
MAXI, 32

**WALL LAMP**

PAG 37



BASIK, 38  
BCN, 40  
CARLOTA, 44  
CARLOTA FL, 46  
CLUB, 48  
FLEXO, 50  
FLEXO LEXA, 52  
LEA, 54  
LEXA, 58  
LEXA FL, 62  
LIBAN, 64  
MEI OVAL, 66  
PLANA, 70  
SILANTRA, 73  
SPOCK, 80  
WALL STREET, 82  
WALL STREET FL, 84  
WALL STREET T5, 86

**PENDANT LAMP**

PAG 89



CALA, 90  
CLUB, 94  
DANONA, 96  
ELEA, 100  
ELIPSE, 104  
GLO, 108  
HARDY, 112  
INARI, 116  
LÁMPARA XVIII, 120  
LUA, 124  
MAR, 126  
MAXI, 128  
MEI, 132  
MEI OVAL, 142  
MOS, 144  
OLIVER, 150  
SIAM, 154  
SILANTRA, 158  
TAU, 162  
TEKNO, 164  
TEKNO CP, 166  
TWINS, 168  
URBAN, 172

**CEILING LAMP**

PAG 177



CALA, 178  
ELEA, 182  
KUADRAT, 186  
OLIVER, 188  
PLAFONET, 192  
RONDO, 196  
SIAM, 198  
URBAN, 202

**TABLE LAMP**

PAG 207

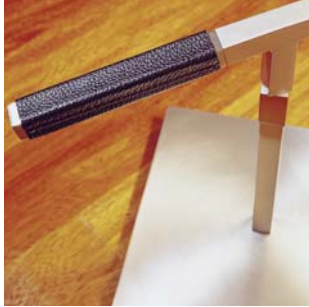

CARLOTA, 208  
 CLUB, 210  
 DANONA, 212  
 EMA, 214  
 INARI, 216  
 MANI, 218  
 MEI OVAL, 220  
 MUF, 222  
 ONNE, 226  
 SPOCK, 230  
 TAU, 234  
 TAU MADERA, 236  
 ULMA, 238

**FLOOR LAMP**

PAG 241



CARLOTA, 242  
 CLUB, 244  
 DANONA, 246  
 EMA, 248  
 INARI, 250  
 MAXI, 252  
 MEI OVAL, 2546  
 SPOCK, 256  
 TAU, 258  
 TAU MADERA, 260  
 ULMA, 262

**HAND-CRAFTING**

PAG 265



AVANI, 266  
 FERRARA, 268  
 TOUS, 280

**TABLE LIGHT**

PAG 283

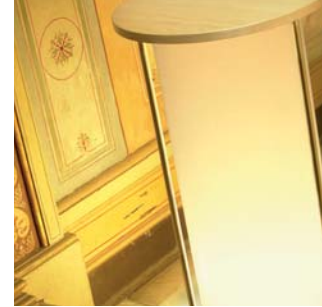

PEANA, 284

**CHRISTOPHE MATHIEU**



**LUIS VIÑAS**



**JOANA BOVER**



**CARLES RIART**



**LLUÍS PORQUERAS**

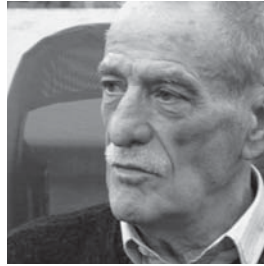

**ALEX FERNÁNDEZ CAMPS**



**GONZALO MILÀ**



**JORDI LLOPIS**



**SERGI & ÒSCAR DEVESA**



*OUTDOOR*

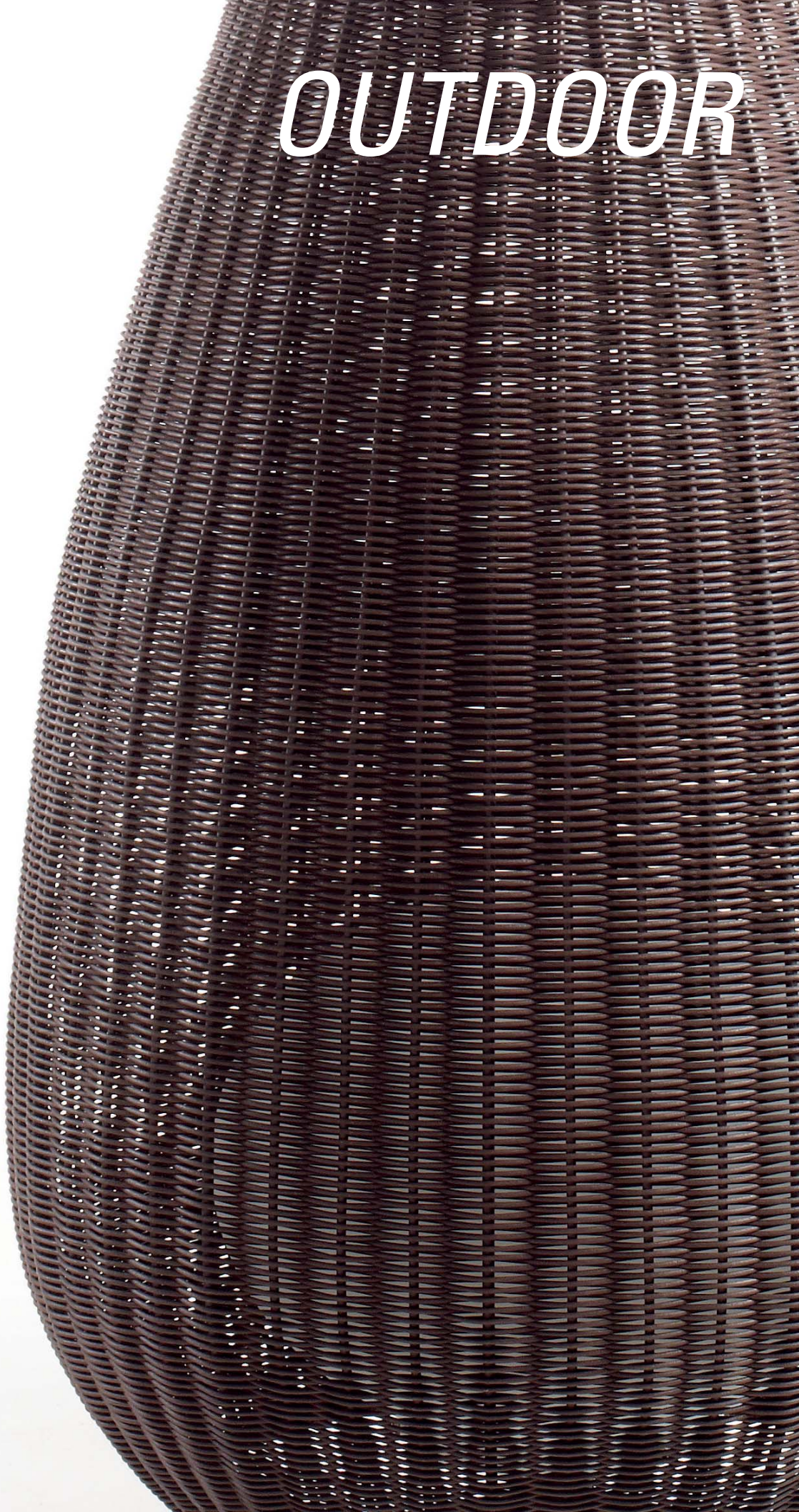

**AMPHORA - 01**  
OUTDOOR FLOOR



2 x 20 W T4 E-26

Dry + wet location

ø 49 cm / 19.29"

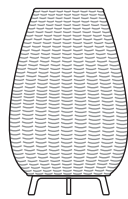

h 77.50 cm / 30.51"

0133003U *BROWN GRAPHITE*

Lampshade 19.29" x 27.36"  
Synthetic Fiber

P-741U *LIGHT BEIGE*

P-742U *BROWN*

**AMPHORA - 02**  
OUTDOOR FLOOR



2 x 29 W T4 E-26

Dry + wet location

ø 80 cm / 31.50"

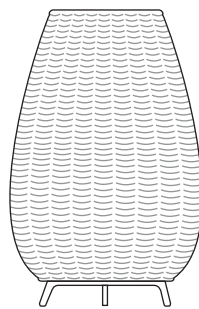

h 123 cm / 48.43"

0233003U *BROWN GRAPHITE*

Lampshade 31.50" x 44.69"  
Synthetic Fiber

P-744U *LIGHT BEIGE*

P-745U *BROWN*

**AMPHORA - 03**  
OUTDOOR FLOOR



2 x 29 W T4 E-26

Dry + wet location

ø 89 cm / 35.04"

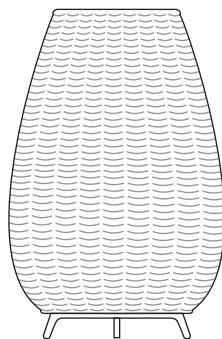

h 137 cm / 53.94"

0333003U *BROWN GRAPHITE*

Lampshade 35.04" x 50"  
Synthetic Fiber

P-747U *LIGHT BEIGE*

P-748U *BROWN*



Special finishings upon request:  
*BROWN CHOCOLATE, WHITE, MUSTARD.*  
Delay: 3 months.

**FINISHING**

*BROWN GRAPHITE*

*LIGHT BEIGE*

*BROWN*

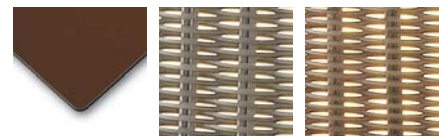











Restaurant Pasarela / La Roca Village



**FORA**

OUTDOOR PENDANT LAMP



2 x 20 W T4 E-26 self ballasted lamp

Dry + wet location

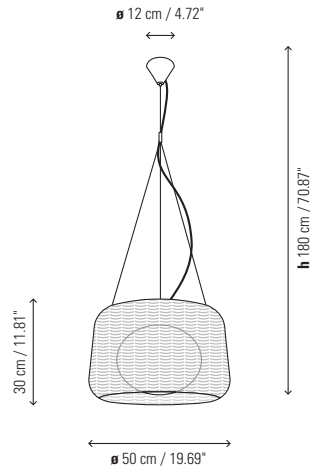

- 4130301U NATURAL WHITE
- 4130303U BROWN GRAPHITE
- 4130308U GREY GRAPHITE

Synthetic Polyethylene Fiber

- P-694 CU GREY GRAPHITE
- P-695 CU LIGHT BEIGE
- P-696 CU BROWN

Light source is protected by polyethylene globe of medium density and UV protection.

Photometry **CE** available

**FORA - 90**

OUTDOOR PENDANT LAMP



2 x 29 W T4 E-26 self ballasted lamp

Dry + wet location

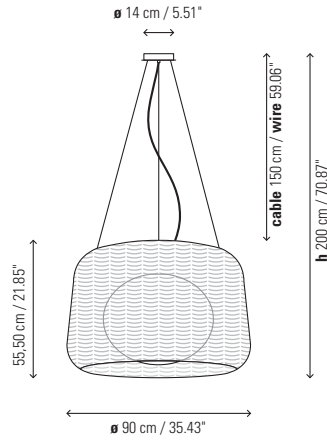

- 4030301U NATURAL WHITE
- 4030303U BROWN GRAPHITE
- 4030308U GREY GRAPHITE

Synthetic Polyethylene Fiber

- P-706 CU GREY GRAPHITE
- P-707 CU LIGHT BEIGE
- P-708 CU BROWN

Light source is protected by polyethylene globe of medium density and UV protection.

Photometry **CE** available



**FAMILY**

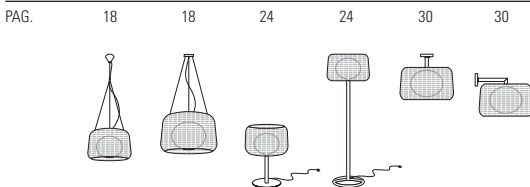

**FINISHING**

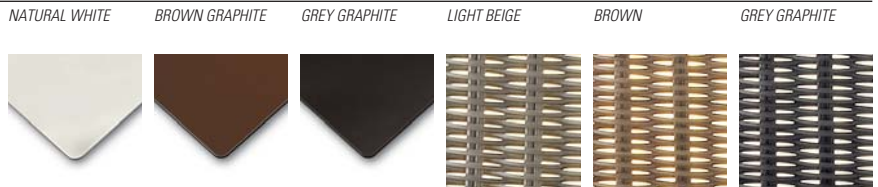













**FORA - MESA**  
OUTDOOR LAMP



2 x 20 W T4 E-26 self ballasted lamp

Dry + wet location

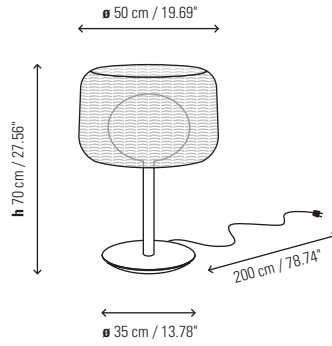

- 2230301U NATURAL WHITE
- 2230303U BROWN GRAPHITE
- 2230308U GREY GRAPHITE

Synthetic Polyethylene Fiber

- P-694U GREY GRAPHITE
- P-695U LIGHT BEIGE
- P-696U BROWN

Light source is protected by polyethylene globe of medium density and UV protection.

Photometry available

**FORA - PIE**  
OUTDOOR LAMP



2 x 20 W T4 E-26 self ballasted lamp

Dry + wet location

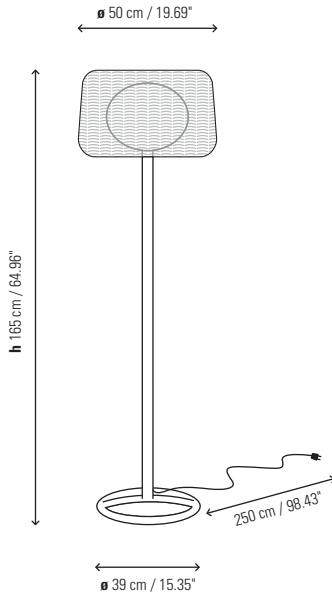

- 3030301U NATURAL WHITE
- 3030303U BROWN GRAPHITE
- 3030308U GREY GRAPHITE

Synthetic Polyethylene Fiber

- P-694U GREY GRAPHITE
- P-695U LIGHT BEIGE
- P-696U BROWN

Light source is protected by polyethylene globe of medium density and UV protection.

The cast iron base is distinguished by a radial base whose tubular design improves durability and allows light to reach the grass.

Consult floor fastening options.

Photometry available



**FAMILY**

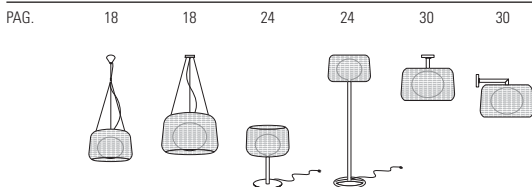

**FINISHING**

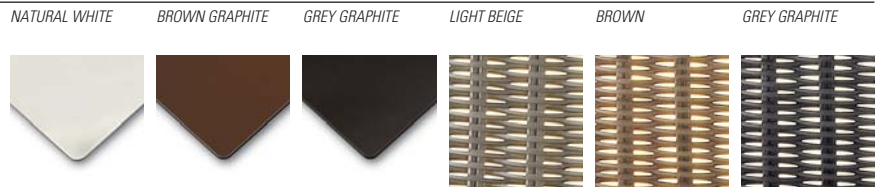





Hotel Nord 1901 / Girona







**FORA - APLIQUE**  
OUTDOOR WALL LIGHT



2 x 20 W T4 E-26 self ballasted lamp

Dry + wet location

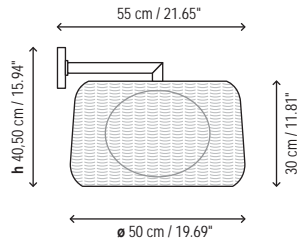

- 1130301U NATURAL WHITE
- 1130303U BROWN GRAPHITE
- 1130308U GREY GRAPHITE

Synthetic Polyethylene Fiber

- P-694 CU GREY GRAPHITE
- P-695 CU LIGHT BEIGE
- P-696 CU BROWN

Photometry  $\text{CE}$  available

**FORA - PLAFÓN**  
OUTDOOR CEILING



2 x 20 W T4 E-26 self ballasted lamp

Dry + wet location

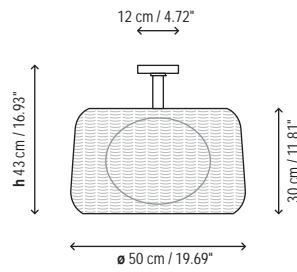

- 5130301U NATURAL WHITE
- 5130303U BROWN GRAPHITE
- 5130308U GREY GRAPHITE

Synthetic Polyethylene Fiber

- P-694 CU GREY GRAPHITE
- P-695 CU LIGHT BEIGE
- P-696 CU BROWN

Photometry  $\text{CE}$  available

**FAMILY**

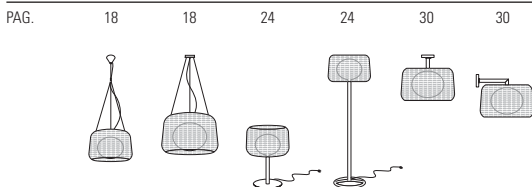

**FINISHING**

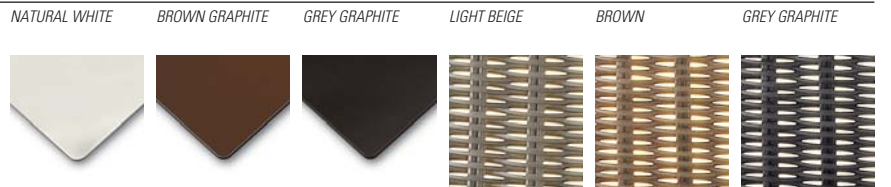





**MAXI - P**  
OUTDOOR LAMP



2 x 54 W T5

Dry + wet location

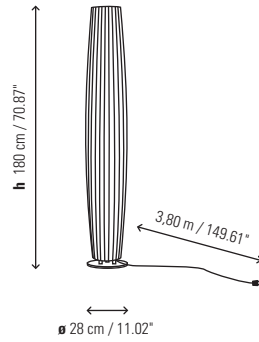

3229500U WHITE

**OPTIONAL**

Supply fluorescent tubes (2x28W) already installed inside the luminaire.

Light source is protected by a Polyethylene Fiber shade  
Suitable for floor mounting

Photometry **CE** available

**MAXI - S**  
OUTDOOR PENDANT LAMP



2 x 54 W T5

Dry + wet location

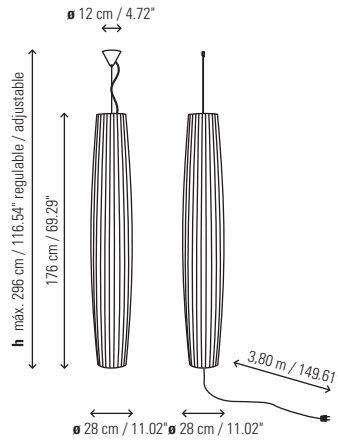

4429500TOPU ELECTRICAL UPPER INSTALLATION

4429500INFU ELECTRICAL BOTTOM INSTALLATION

**OPTIONAL**

Supply fluorescent tubes (2x28W) already installed inside the luminaire.

Light source is protected by a Polyethylene shade  
Adjustable tensor wire  
White canopy finished  
Only for Upper installation

Rigid stem available upon request

Photometry **CE** available

**FAMILY**

PAG. 32 32 32 142 142 142 274 274

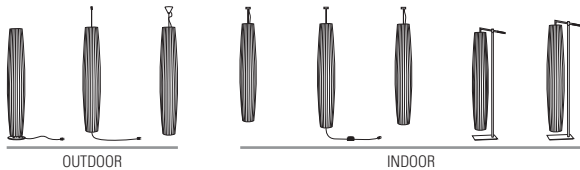

**FINISHING**

WHITE





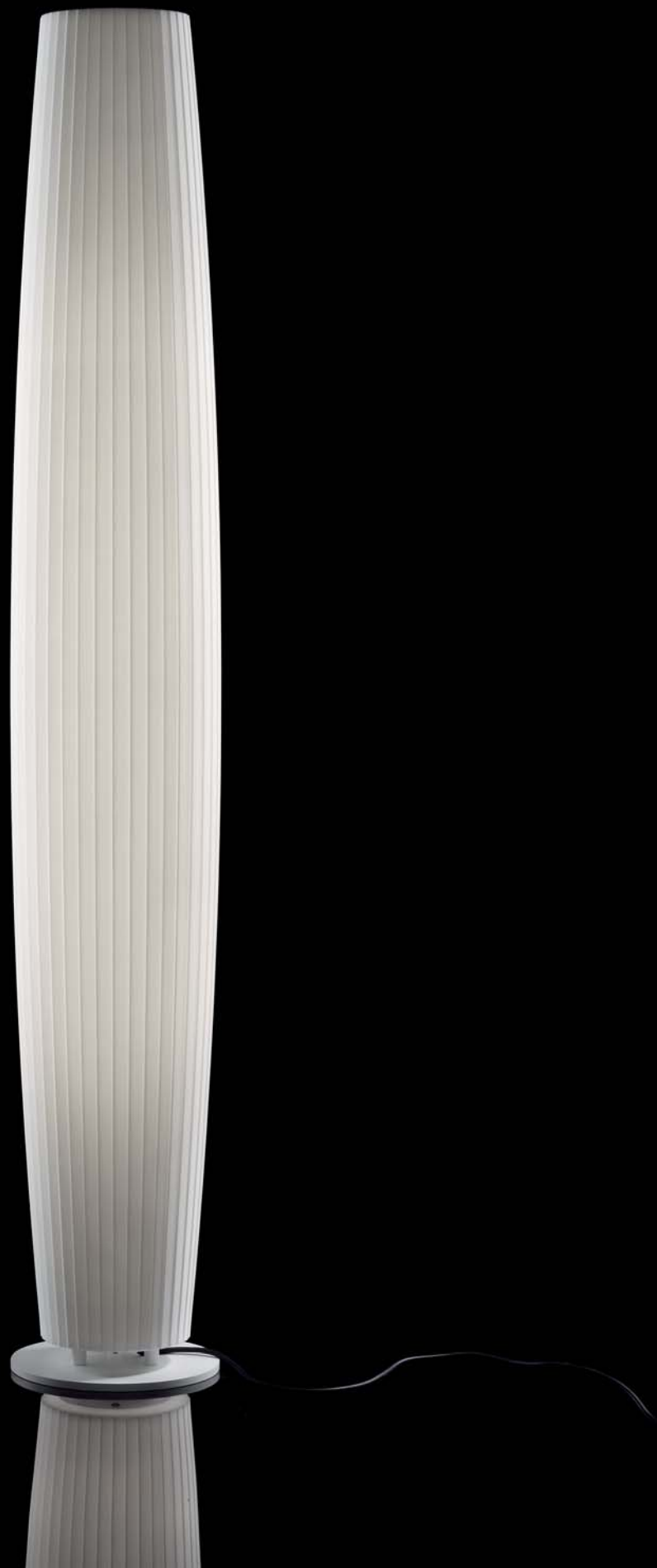

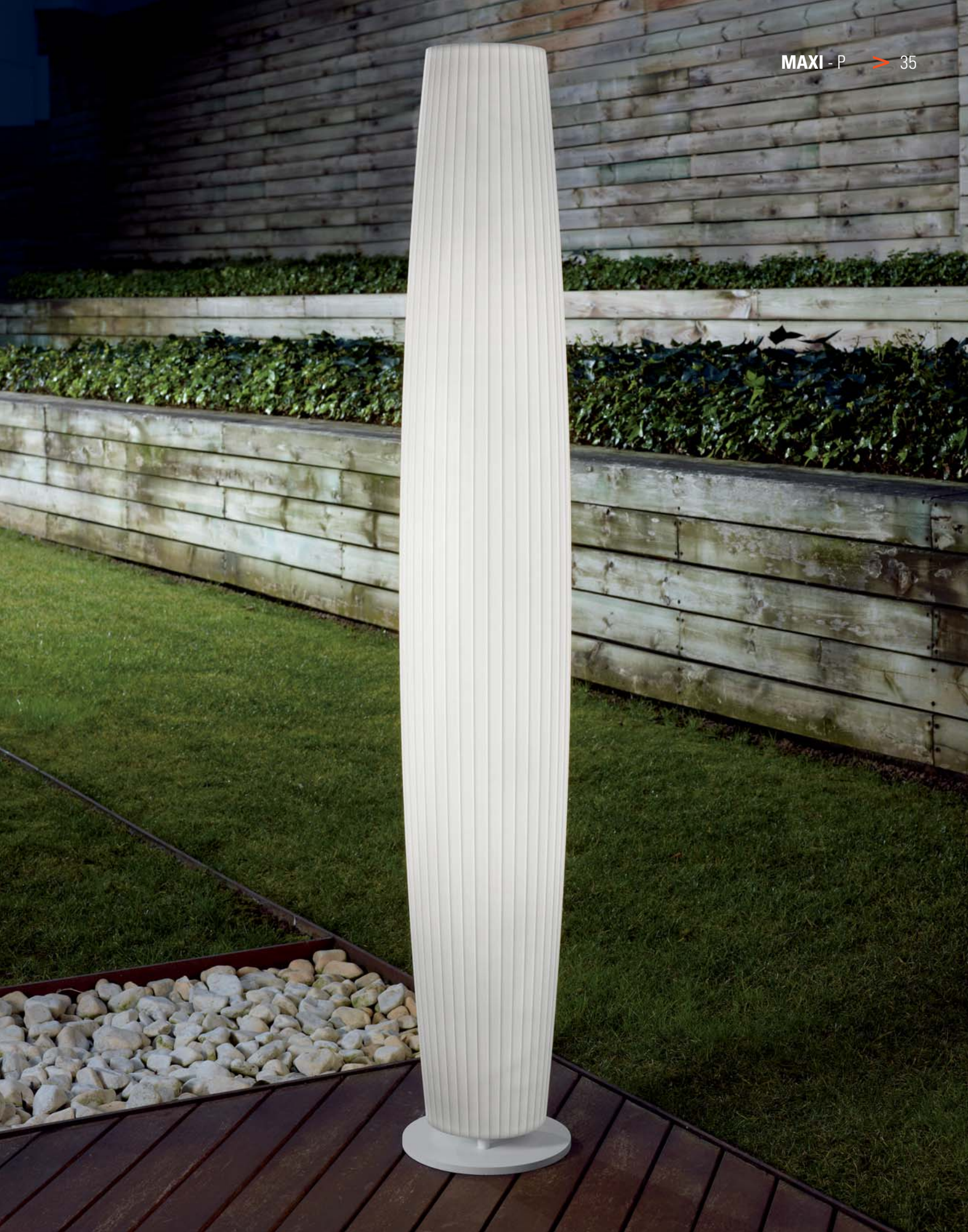



# WALL LAMP



*IMPORTANT NOTE:  
Wall sconce product photography doesn't show US blackplate mounting.*

**BASIK - 02**  
WALL LAMP



1 x 60 W A-15 E-26



1 x 13 W twist lock GU24 self ballasted

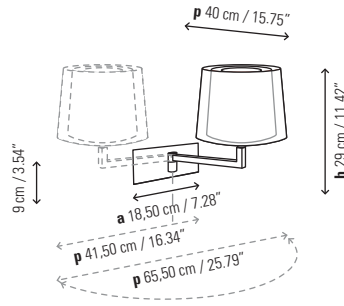

- 1132105U SATIN NICKEL
- 1132106U BRILLIANT CHROME

- 1132105GU SATIN NICKEL / GU24
- 1132106GU BRILLIANT CHROME / GU24

Outer lampshade 8.66" x 6.30" x 7.09"  
P-633EU WHITE COTTON  
Cotton shade without upper diffuser

- P-634EU WHITE TRANSLUCENT RIBBON
- P-635EU CREAM TRANSLUCENT RIBBON

- P-636EU BLACK MESH
  - P-637EU RED MESH
- Outer lampshade: PVC cristal

Inner lampshade  
P-636IU BLACK MESH  
P-637IU REDMESH  
Inner shade made of a fireresistent polyester rigid film

Swivel arm  
Surface back box: 6.69" x 3.54"

**FINISHING**

BRILLIANT CHROME SATIN NICKEL BLACK MESH RED MESH CREAM RIBBON WHITE RIBBON WHITE COTTON







**BCN**  
WALL LAMP



2 x 24 W T5

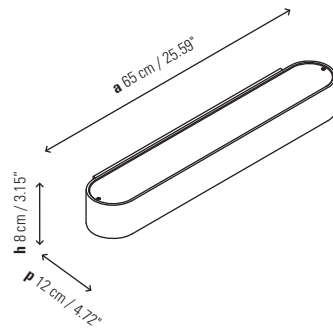

- 1526501U ELECTRONIC BALLAST / WHITE BRILLIANT LACQUER
- 1526523U ELECTRONIC BALLAST / BLACK BRILLIANT LACQUER
- 1526522U ELECTRONIC BALLAST / RED BRILLIANT LACQUER

- D1526501U DIMMING BALLAST / WHITE BRILLIANT LACQUER
- D1526523U DIMMING BALLAST / BLACK BRILLIANT LACQUER
- D1526522U DIMMING BALLAST / RED BRILLIANT LACQUER

Material: Polyurethane/brilliant lacquer finish

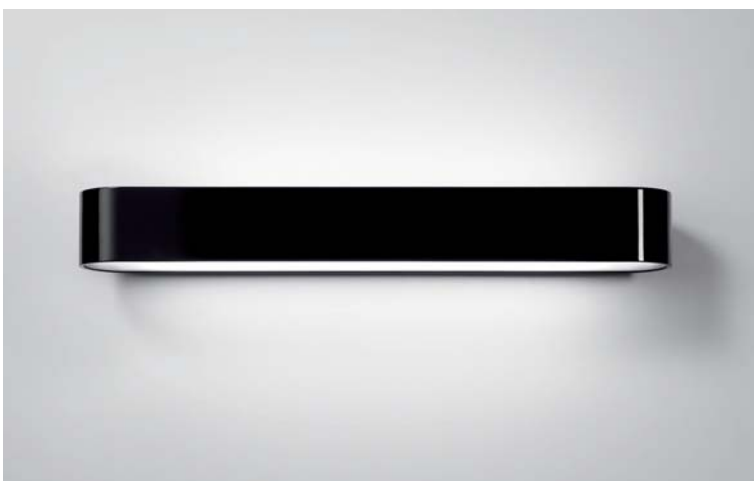

**FINISHING**

WHITE LACQUER    BLACK LACQUER    RED LACQUER









**CARLOTA**  
WALL LAMP



1 x 60 W A-15 E-26

1 x 13 W twist lock GU24 self ballasted

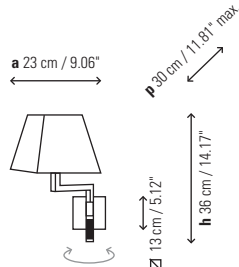

- 1024005U SATIN NICKEL
- 1024006U BRILLIANT CHROME
- 1024060U NICKEL DARK LEATHER
- 1024061U NICKEL CARAMEL LEATHER
- 1024005GU SATIN NICKEL / GU24
- 1024006GU BRILLIANT CHROME / GU24
- 1024060GU NICKEL DARK LEATHER / GU24
- 1024061GU NICKEL CARAMEL LEATHER / GU24

Square lampshade 7.87" x 5.91" x 3.94"

- P-107U COTTON
- P-202U WHITE TRANSLUCENT RIBBON
- P-203U CREAM TRANSLUCENT RIBBON

Surface back box  $\varnothing$  4.33"  
Swivel arm

**CARLOTA - G**  
WALL LAMP



1 x 60 W A-15 E-26

1 x 13 W twist lock GU24 self ballasted

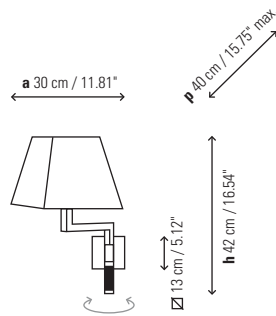

- 1524005U SATIN NICKEL
- 1524006U BRILLIANT CHROME
- 1524060U NICKEL DARK LEATHER
- 1524061U NICKEL CARAMEL LEATHER
- 1524005GU SATIN NICKEL / GU24
- 1524006GU BRILLIANT CHROME / GU24
- 1524060GU NICKEL DARK LEATHER / GU24
- 1524061GU NICKEL CARAMEL LEATHER / GU24

Square lampshade 9.06" x 6.69" x 4.72"

- P-487U COTTON
- P-486U WHITE TRANSLUCENT RIBBON
- P-489U CREAM TRANSLUCENT RIBBON

Surface back box  $\varnothing$  4.33"  
Swivel arm

**CARLOTA - DOBLE ARTICULADO**  
WALL LAMP



1 x 60 W A-15 E-26

1 x 13 W twist lock GU24 self ballasted

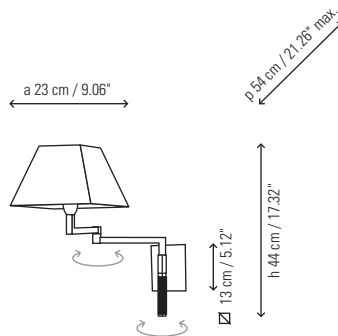

- 0924005U SATIN NICKEL
- 0924006U BRILLIANT CHROME
- 0924060U NICKEL DARK LEATHER
- 0924061U NICKEL CARAMEL LEATHER
- 0924005GU SATIN NICKEL / GU24
- 0924006GU BRILLIANT CHROME / GU24
- 0924060GU NICKEL DARK LEATHER / GU24
- 0924061GU NICKEL CARAMEL LEATHER / GU24

Square lampshade 9.06" x 6.69" x 4.72"

- P-487U COTTON
- P-486U WHITE TRANSLUCENT RIBBON
- P-489U CREAM TRANSLUCENT RIBBON

Surface back box  $\varnothing$  4.33"  
Swivel arm



**FINISHING**

COTTON CREAM RIBBON WHITE RIBBON



BRILLIANT CHROME SATIN NICKEL DARK LEATHER CARAMEL LEATHER

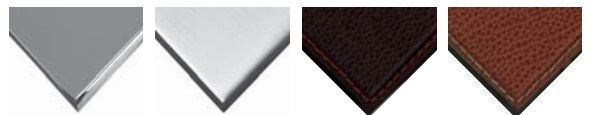

**FAMILY**

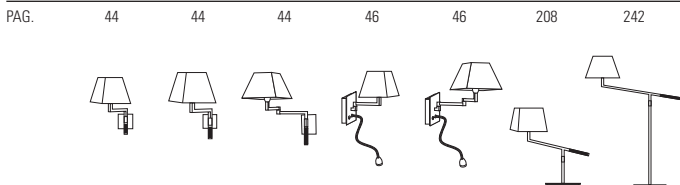



**CARLOTA - G FL**  
WALL LAMP



1 x 60 W A-15 E-26



1 x 13 W twist lock GU24 self ballasted



1 x 1.2 W LED

Led: 1.2 W Phillips

Optics: 45°

Lumens: 85 lm

Degrees Kelvin: 2.900°

CRI: 85

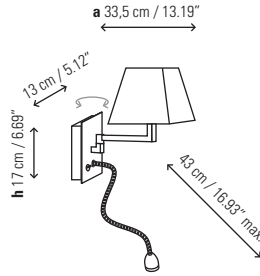

- F524005U SATIN NICKEL
- F524006U BRILLIANT CHROME
- F524060U NICKEL DARK LEATHER
- F524061U NICKEL CARAMEL LEATHER

- F524005GU SATIN NICKEL / GU24
- F524006GU BRILLIANT CHROME / GU24
- F524060GU NICKEL DARK LEATHER / GU24
- F524061GU NICKEL CARAMEL LEATHER / GU24

Lampshade 9.06" x 6.69" x 4.72"

- P-487U COTTON
- P-486U WHITE TRANSLUCENT RIBBON
- P-489U CREAM TRANSLUCENT RIBBON

Surface back box 4.33" x 5.91"

Swivel arm

Flexo made in brass to ensure greater flexibility and rigidity.

**CARLOTA - DOBLE FL**  
APLIQUE  
WALL LAMP



1 x 60 W A-15 E-26



1 x 13 W twist lock GU24 self ballasted



1 x 1.2 W LED

Led: 1.2 W Phillips

Optics: 45°

Lumens: 85 lm

Degrees Kelvin: 2.900°

CRI: 85

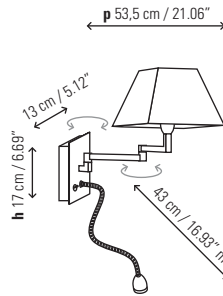

- F924005U SATIN NICKEL
- F924006U BRILLIANT CHROME
- F924060U NICKEL DARK LEATHER
- F924061U NICKEL CARAMEL LEATHER

- F924005GU SATIN NICKEL / GU24
- F924006GU BRILLIANT CHROME / GU24
- F924060GU NICKEL DARK LEATHER / GU24
- F924061GU NICKEL CARAMEL LEATHER / GU24

Lampshade 9.06" x 6.69" x 4.72"

- P-487U COTTON
- P-486U WHITE TRANSLUCENT RIBBON
- P-489U CREAM TRANSLUCENT RIBBON

Surface back box 4.33" x 5.91"

Swivel arm

Flexo made in brass to ensure greater flexibility and rigidity.

**FINISHING**

COTTON CREAM RIBBON WHITE RIBBON





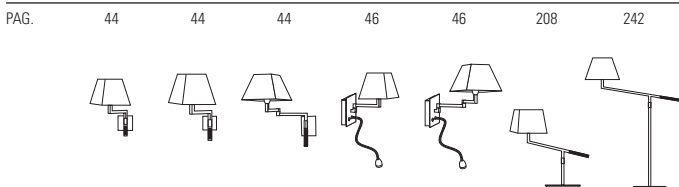
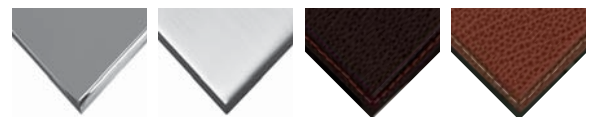

BRILLIANT CHROME SATIN NICKEL DARK LEATHER CARAMEL LEATHER







**CLUB - A**  
WALL LAMP

-  
-  1 x 60 W A-15 E-26
-  1 x 13 W T2 E-26 self ballasted

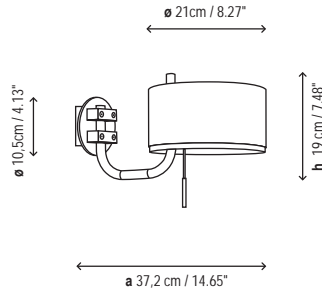





1532812U MATTE BLACK-NICKEL

LAMPSHADE  
Black aluminum shade  
White PVC interior B1 Flame Resistant  
Included aluminum top diffuser

**No swivel arm**  
Lampholder swicht

**CLUB - A2L**  
WALL LAMP

-  
-  2 x 60 W A-15 E-26
-  1 x 13 W T2 E-26 self ballasted

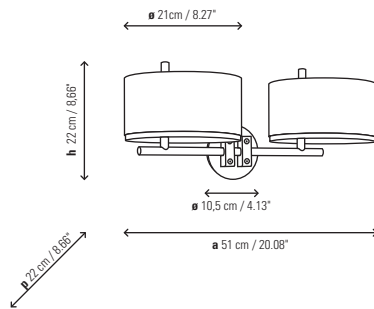

1232812U MATTE BLACK-NICKEL

LAMPSHADE  
Black aluminum shade  
White PVC interior B1 Flame Resistant  
Included aluminum top diffuser



**FAMILY**

PAG. 48 48 94 210 244

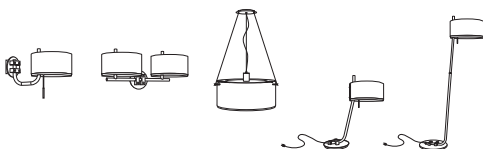

**FINISHING**

BRILLIANT CHROME MATTE BLACK

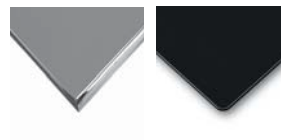



**FLEXP**  
WALL LAMP



1 x 1.2 W LED  
 Led: 1.2 W Phillips  
 Optics: 45°  
 Lumens: 85 lm  
 Degrees Kelvin: 2.900°  
 CRI: 85

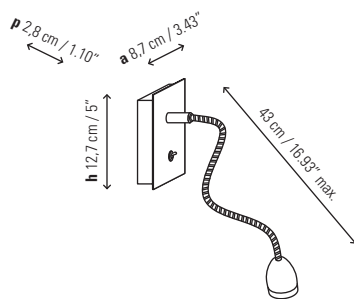

- FL25106U CHROME
- FL25105U SATIN NICKEL
- FL25160U NICKEL DARK LEATHER
- FL25161U NICKEL CARAMEL LEATHER
- FL25116U RED GLASS CHROME
- FL25117U BLACK GLASS CHROME

*Flexo made in brass to ensure greater flexibility and rigidity.  
 Aluminium hood and switch on back plate.  
 Surface back box 4.25" x 2.64"*

*Must mount horizontally on 2" x 4" rectangular junction box.*

Photometry available



**FINISHING**

BRILLIANT CHROME    SATIN NICKEL    DARK LEATHER    CARAMEL LEATHER    RED GLASS    BLACK GLASS

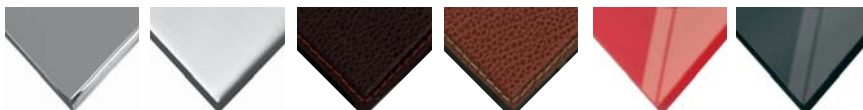



**FLEXO LEXA**  
WALL LAMP



1 x 1.2 W LED  
 Led: 1.2 W Phillips  
 Optics: 45°  
 Lumens: 85 lm  
 Degrees Kelvin: 2.900°  
 CRI: 85

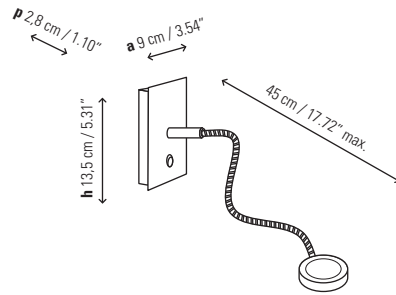

FL20505U SATIN NICKEL  
 FL20506U BRILLIANT CHROME

*Flexo made in brass to ensure greater flexibility and rigidity, with Zamac injection. Hood and switch on back plate.*  
 Surface back box 4.72" x 3.15"

Must mount horizontally on 2" x 4" rectangular junction box.

Photometry **CE** available



**FINISHING**

BRILLIANT CHROME SATIN NICKEL

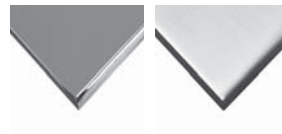



**LEA - 01**

WALL LAMP



1 x 24 W T5

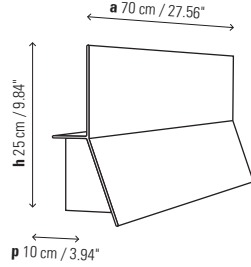

0121501U ELECTRONIC BALLAST / WHITE

D0121501U DIMMING BALLAST / WHITE

Polycarbonate diffuser included  
Upper shelf bears until 4 kg

Special colors: RAL number to be indicated.  
Minimum quantity: 30 pieces.

**LEA - 02**

WALL LAMP



1 x 39 W T5

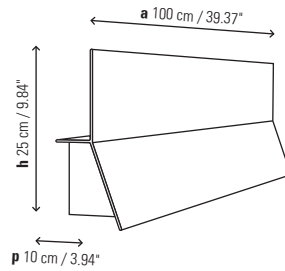

0221501U ELECTRONIC BALLAST / WHITE

D0221501U DIMMING BALLAST / WHITE

Polycarbonate diffuser included  
Upper shelf bears until 4 kg

Special colors: RAL number to be indicated.  
Minimum quantity: 30 pieces.

**LEA - 03**

WALL LAMP



1 x 54 W T5

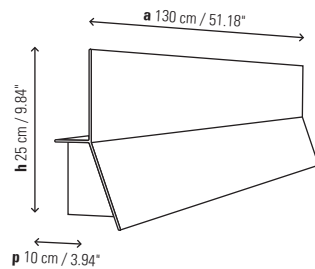

0321501U ELECTRONIC BALLAST / WHITE

D0321501U DIMMING BALLAST / WHITE

Polycarbonate diffuser included  
Upper shelf bears until 4 kg

Special colors: RAL number to be indicated.  
Minimum quantity: 30 pieces.



Optional switch / Consult

**FINISHING**

LEA WHITE











**LEXA**  
WALL LAMP



1 x 60 W A-15 E-26



1 x 13 W twist lock GU24 self ballasted

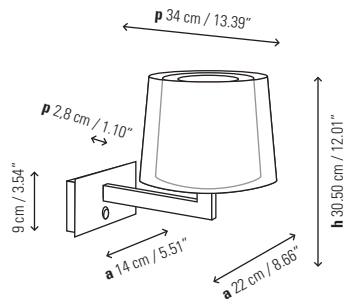
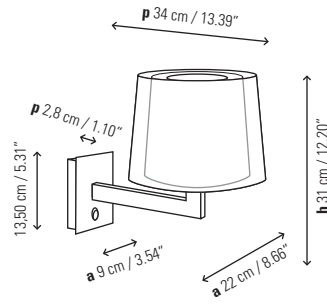

Vertical Backplate-box 3.54" x 5.31"

- 1120505U SATIN NICKEL
- 1120506U BRILLIANT CHROME
- 1120505GU SATIN NICKEL / GU24
- 1120506GU BRILLIANT CHROME / GU24

Horizontal Backplate-box 5.51" x 3.54"

- 1320505U SATIN NICKEL
- 1320506U BRILLIANT CHROME
- 1320505GU SATIN NICKEL / GU24
- 1320506GU BRILLIANT CHROME / GU24

Must mount horizontally on 2" x 4" rectangular junction box.

Outer lampshade 8.66" x 6.30" x 7.09"

- P-633EU WHITE COTTON
- Cotton shade without upper diffuser

- P-634EU WHITE TRANSLUCENT RIBBON
- P-635EU CREAM TRANSLUCENT RIBBON

- P-636EU BLACK MESH
- P-637EU RED MESH
- Outer lampshade: PVC cristal

Inner lampshade

- P-636IU BLACK MESH
- P-637IU RED MESH

Inner shade made of a fire-resistant polyester rigid film



**FINISHING**

BRILLIANT CHROME SATIN NICKEL BLACK MESH RED MESH COTTON WHITE CREAM RIBBON WHITE RIBBON











**LEXA FL**  
WALL LAMP



-  1 x 60 W A-15 E-26
-  1 x 13 W twist lock GU24 self ballasted
-  1 x 1.2 W LED
- Led: 1.2 W Phillips
- Optics: 45°
- Lumens: 85 lm
- Degrees Kelvin: 2.900°
- CRI: 85

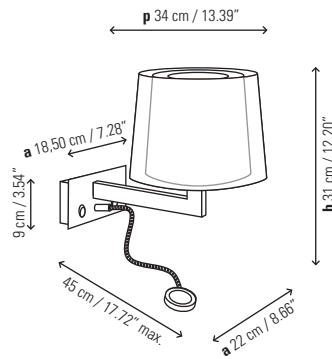
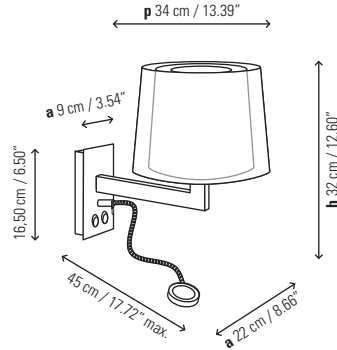

- Vertical Backplate-box 3.54" x 6.50"*
- 1220505U SATIN NICKEL
  - 1220506U BRILLIANT CHROME
  - 1220505GU SATIN NICKEL / GU24
  - 1220506GU BRILLIANT CHROME / GU24

- Horizontal Backplate-box 7.28" x 3.54"*
- 1020505U SATIN NICKEL
  - 1020506U BRILLIANT CHROME
  - 1020505GU SATIN NICKEL / GU24
  - 1020506GU BRILLIANT CHROME / GU24

*Flexo made in brass to ensure greater flexibility and rigidity, with Zamac injection. Hood and switch on back plate. Must mount horizontally on 2" x 4" rectangular junction box.*

- Outer lampshade 8.66" x 6.30" x 7.09"*
- P-633EU WHITE COTTON
  - Cotton shade without upper diffuser

- P-634EU WHITE TRANSLUCENT RIBBON
- P-635EU CREAM TRANSLUCENT RIBBON

- P-636EU BLACK MESH
- P-637EU RED MESH
- Outer lampshade: PVC cristal

- Inner lampshade*
- P-636IU BLACK MESH
  - P-637IU RED MESH
  - Inner shade made of a fire-resistant polyester rigid film



**FINISHING**

- BRILLIANT CHROME    SATIN NICKEL    BLACK MESH    RED MESH    COTTON WHITE    CREAM RIBBON    WHITE RIBBON







**LIBAN**  
WALL LAMP



1 x 75 W T3 Rs7 118 mm

1 x 13 W G24q1

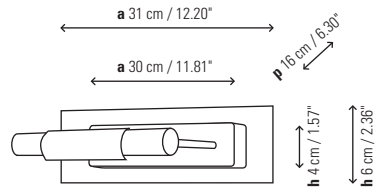

1118605U SATIN NICKEL  
1118606U BRILLIANT CHROME

1118605GU SATIN NICKEL / G24q1  
1118606GU BRILLIANT CHROME / G24q1

Surface back box 11.02" x 1.57"

Must mount horizontally on 2" x 4" rectangular junction box.

**FINISHING**

BRILLIANT CHROME SATIN NICKEL

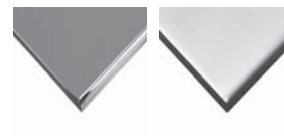

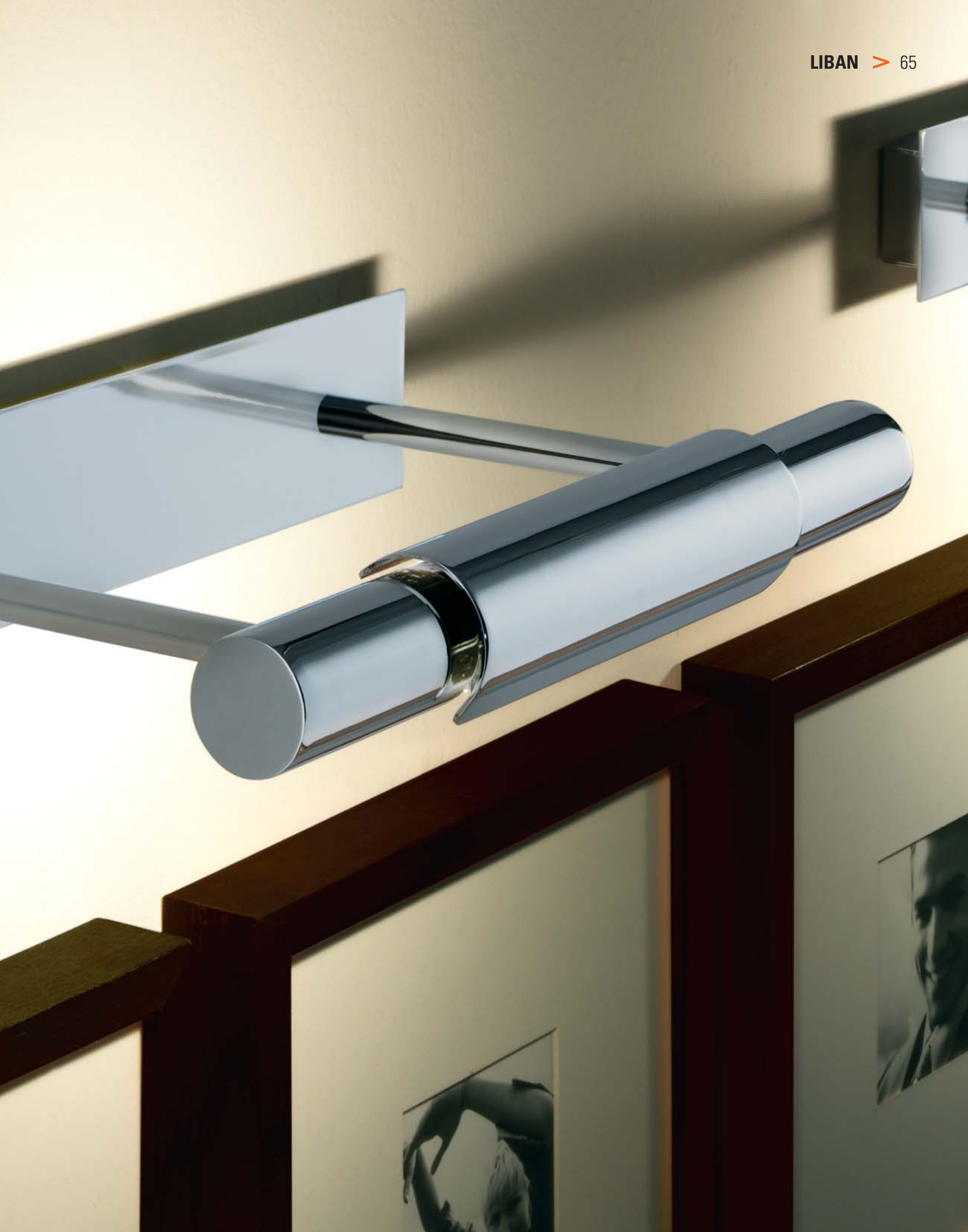

**MEI OVAL - 02**

WALL LAMP



1 x 60 W A-15 E-26

1 x 13 W twist lock GU24 self ballasted lamp

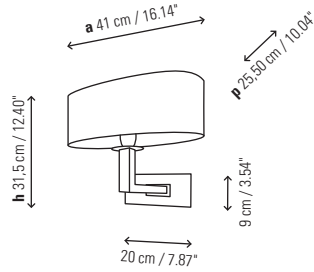

- 1125005U SATIN NICKEL
- 1125006U BRILLIANT CHROME
- 1125060U NICKEL DARK LEATHER
- 1125061U NICKEL CARAMEL LEATHER
- 1125017U CHROME BLACK GLASS

- 1125005GU SATIN NICKEL / GU24
- 1125006GU BRILLIANT CHROME / GU24
- 1125060GU NICKEL DARK LEATHER / GU24
- 1125061GU NICKEL CARAMEL LEATHER / GU24
- 1125017GU CHROME BLACK GLASS / GU24

Oval lampshade 16.14" x 6.89" x 5.91"  
 Shade with upper diffuser can only go with ECO-CLASSIC bulbs.  
 NOT suitable with compact bulbs.

- P-551U WHITE TRANSLUCENT RIBBON
- P-552U CREAM TRANSLUCENT RIBBON
- P-553U BLACK TRANSLUCENT RIBBON
- P-554U WHITE COTTON

Standard shade does not include the black glass diffuser. See Mei Oval mesa shade for reference.

**FINISHING**

WHITE RIBBON    CREAM RIBBON    BLACK RIBBON    WHITE COTTON



**FAMILY**

PAG. 66 142 220 254

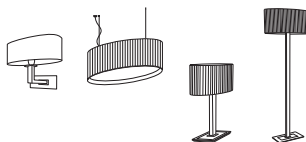

BRILLIANT CHROME    SATIN NICKEL    BLACK GLASS    DARK LEATHER    CARAMEL LEATHER









**PLANA - T5**  
WALL LAMP



2 x 24 W T5

Only for USA not Canada.  
Surface bach box 11.02 x 1,57

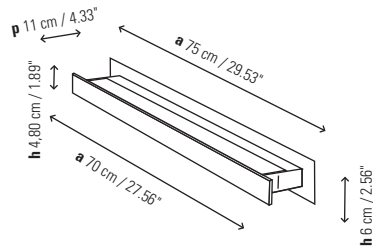

T519805U SATIN NICKEL  
T519806U BRILLIANT CHROME

Photometry **CE** available

**FINISHING**

BRILLIANT CHROME SATIN NICKEL

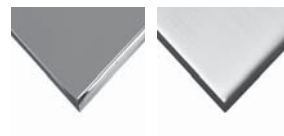







**DESIGN PLUS**

**SILANTRA COLLECTION**  
AWARDED WITH DESIGN PLUS  
PRIZE( L+B, FRANKFURT)2006.

SILANTRA > 73



**SILANTRA - 03**  
WALL LAMP



2 x 18 W 2G-11

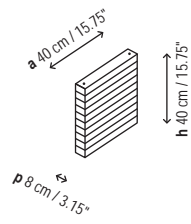

F245529U POLISHED ALUMINIUM-CREAM TRANSLUCENT RIBBON (FLUORESCENT)

F245530U POLISHED ALUMINIUM-WHITE TRANSLUCENT RIBBON (FLUORESCENT)

Lampshade 15.75" x 15.75"

No dimmable

Photometry **CE** available

**FAMILY**

PAG. 74 76 76 76 158

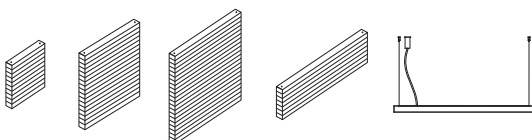

**FINISHING**

POLISHED ALUMINIUM CREAM RIBBON WHITE RIBBON





**SILANTRA - 04**

WALL LAMP - CEILING



4 x 24 W T5

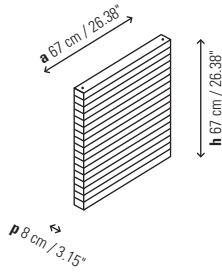

4245531U ELECTRONIC BALLAST / CREAM TRANSLUCENT RIBBON

4245532U ELECTRONIC BALLAST / WHITE TRANSLUCENT RIBBON

D4245531U DIMMING BALLAST / CREAM TRANSLUCENT RIBBON

D4245532U DIMMING BALLAST / WHITE TRANSLUCENT RIBBON

Polished aluminium  
Lampshade 26.38" x 26.38"

Photometry **CE** available

**SILANTRA - 05**

WALL LAMP - CEILING



4 x 39 W T5 Fluorescente

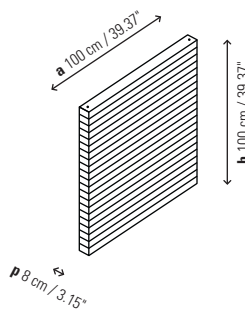

5245533U ELECTRONIC BALLAST / CREAM TRANSLUCENT RIBBON

5245534U ELECTRONIC BALLAST / WHITE TRANSLUCENT RIBBON

D5245533U DIMMING BALLAST / CREAM TRANSLUCENT RIBBON

D5245534U DIMMING BALLAST / WHITE TRANSLUCENT RIBBON

Polished aluminium  
Lampshade 39.37" x 39.37"

Photometry **CE** available

**SILANTRA - 06**

WALL LAMP - CEILING



2 x 39 W T5

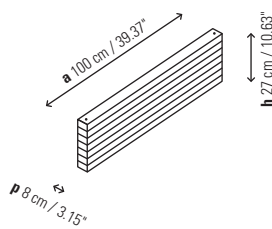

6245535U ELECTRONIC BALLAST / CREAM TRANSLUCENT RIBBON

6245536U ELECTRONIC BALLAST / WHITE TRANSLUCENT RIBBON

D6245535U DIMMING BALLAST / CREAM TRANSLUCENT RIBBON

D6245536U DIMMING BALLAST / WHITE TRANSLUCENT RIBBON

Polished aluminium  
Lampshade 39.37" x 10.63"

Photometry **CE** available

**FAMILY**

PAG. 74 76 76 76 158

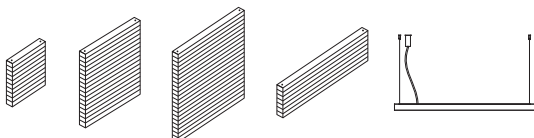

**FINISHING**

POLISHED ALUMINIUM CREAM RIBBON WHITE RIBBON











**SPOCK - A**

WALL LAMP



4 x 1.2 W LED  
 Led: 4 x 1.2 W = 4.8 Phillips  
 Optics: 45°  
 Lumens: 85 x 4 = 340 lm  
 Degrees Kelvin: 2.900°  
 CRI: 85

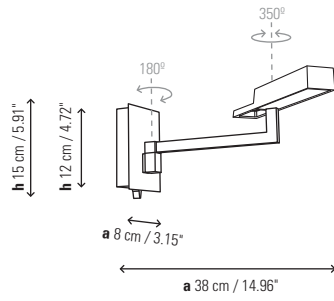

- 1110505LU NICKEL
- 1110506LU CHROME
- 1110511LU CHROME-WHITE
- 1110510LU CHROME-GRAPHITE

Photometry available



**FAMILY**

PAG. 90 252 252 280

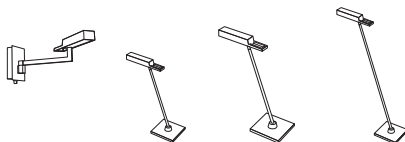

**FINISHING**

BRILLIANT CHROME WHITE GRAPHITE SATIN NICKEL

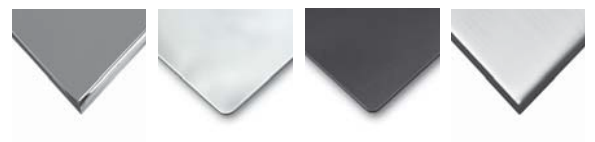



**WALL STREET**

WALL LAMP



1 x 60 W A-15 E-26

1 x 13 W twist lock GU24 self ballasted lamp

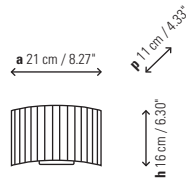
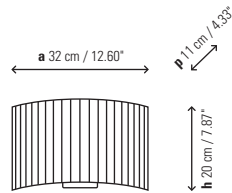
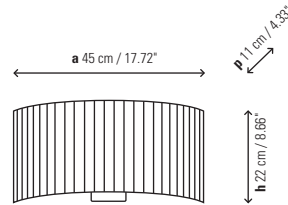

- 1118505U SATIN NICKEL
- 1118504U BLACK IRON
- 1118503U GRAPHITE BROWN IRON

- 1118505GU SATIN NICKEL / GU24
- 1118504GU BLACK IRON / GU24
- 1118503GU GRAPHITE BROWN IRON / GU24

Lampshade 17.72" x 8.66"

- P-294U PARCHMENT
- P-295U PLEATED
- P-296U COTTON
- P-297U WHITE COTTON
- P-298U CREAM TRANSLUCENT RIBBON
- P-299U WHITE TRANSLUCENT RIBBON

Lampshade 12.60" x 7.87"

- P-335U PARCHMENT
- P-338U PLEATED
- P-339U COTTON
- P-332U WHITE COTTON
- P-333U CREAM TRANSLUCENT RIBBON
- P-334U WHITE TRANSLUCENT RIBBON

Lampshade 8.27" x 6.30"

- P-343U PARCHMENT
- P-346U PLEATED
- P-347U COTTON
- P-342U WHITE COTTON
- P-355U CREAM TRANSLUCENT RIBBON
- P-356U WHITE TRANSLUCENT RIBBON

Surface back box 3.15" x 1.97"



**FINISHING**

SATIN NICKEL    BROWN IRON    BLACK IRON    PARCHMENT    PLEATED    COTTON    WHITE COTTON    CREAM RIBBON    WHITE RIBBON





**WALL STREET FL**

WALL LAMP



1 x 60 W A-15 E-26



1 x 13 W twist lock GU24 self ballasted lamp



1 x 1.2 W LED

Led: 1.2 W Phillips

Optics: 45°

Lumens: 85 lm

Degrees Kelvin: 2.900°

CRI: 85

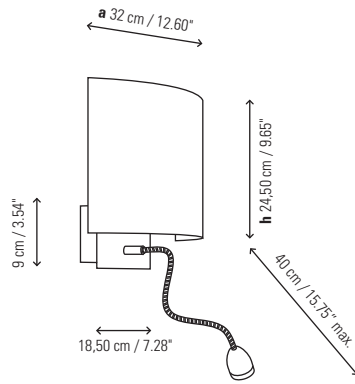

1118505FLU SATIN NICKEL

1118506FLU BRILLIANT CHROME

1118505FLGU SATIN NICKEL / GU24

1118506FLGU BRILLIANT CHROME / GU24

Lampshade 12.60" x 7.87"

P-335U PARCHMENT

P-338U PLEATED

P-339U COTTON

P-332U WHITE COTTON

P-333U CREAM TRANSLUCENT RIBBON

P-334U WHITE TRANSLUCENT RIBBON

Surface back box: 6.69" x 2.95"

Flexo made in brass to ensure greater flexibility and rigidity

**FINISHING**

BRILLIANT CHROME

SATIN NICKEL

PARCHMENT

PLEATED

COTTON

WHITE COTTON

CREAM RIBBON

WHITE RIBBON





**WALL STREET T5 - 01**

WALL LAMP

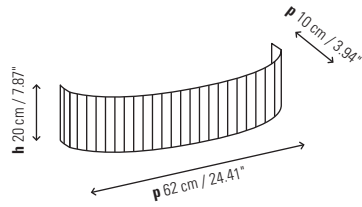

T529001U WHITE STRUCTURE T-5/01

Lampshade T-5/01

- P-605U WHITE COTTON
- P-606U WHITE TRANSLUCENT RIBBON
- P-607U CREAM TRANSLUCENT RIBBON

Wall lamp measures are according to T-5 HO Fluorescents

**WALL STREET T5 - 02**

WALL LAMP

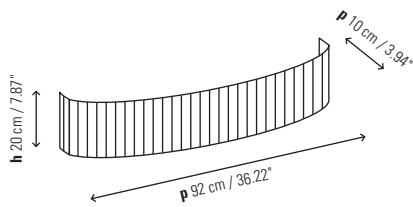

T529002U WHITE STRUCTURE T-5/02

Lampshade T-5/02

- P-611U WHITE COTTON
- P-612U WHITE TRANSLUCENT RIBBON
- P-613U CREAM TRANSLUCENT RIBBON

Wall lamp measures are according to T-5 HO Fluorescents

**BIG FORMAT**

**FINISHING**

WHITE COTTON CREAM RIBBON WHITE RIBBON







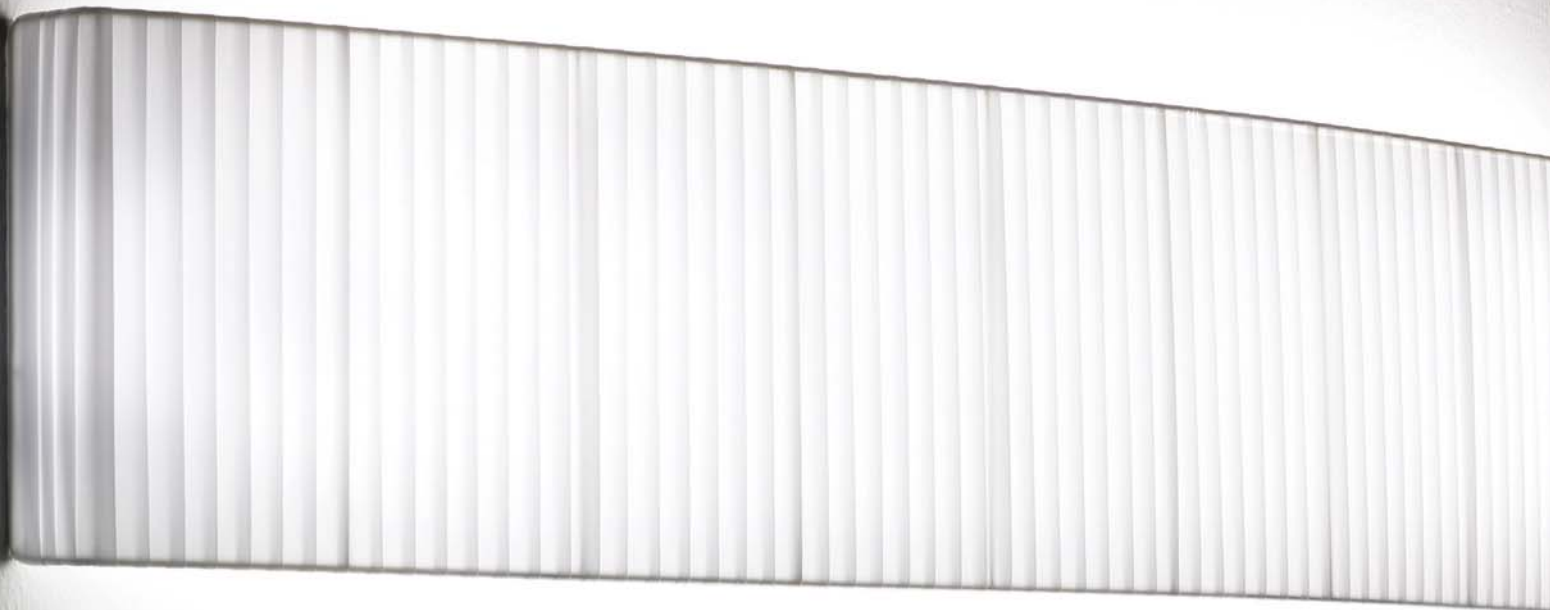

# *PENDANT LAMP*

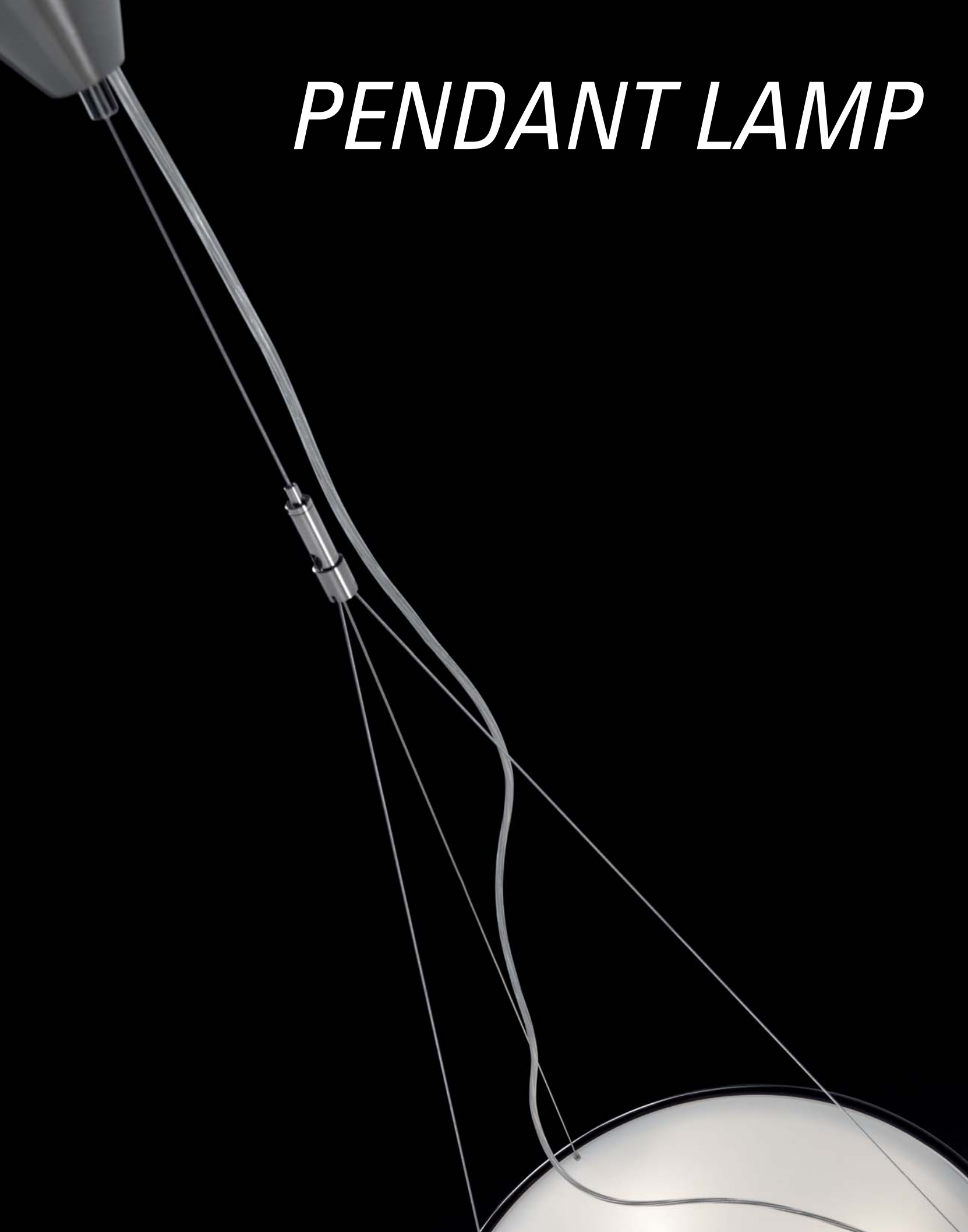

**CALA**  
PENDANT LAMP



4 x 60 W A-15 E-26

4 x 20 W T4 E-26

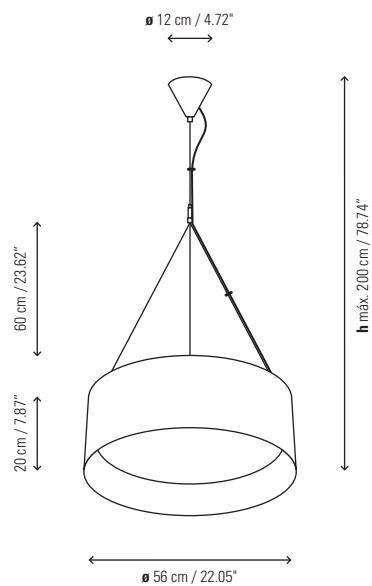

- 4132601U WHITE BRILLIANT LACQUER
- 4132623U BLACK BRILLIANT LACQUER
- 4132622U RED BRILLIANT LACQUER

Finishing: brilliant lacquer

Material: Polyurethane

Adjustable tensor wire

**FAMILY**

PAG. 90 178

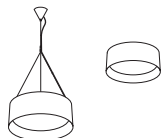

**FINISHING**

RED LACQUER WHITE LACQUER BLACK LACQUER









**CLUB - S**  
PENDANT LAMP



3 x 60 W A-19 E-26

3 x 15 W T3 E-26  
self ballasted lamp

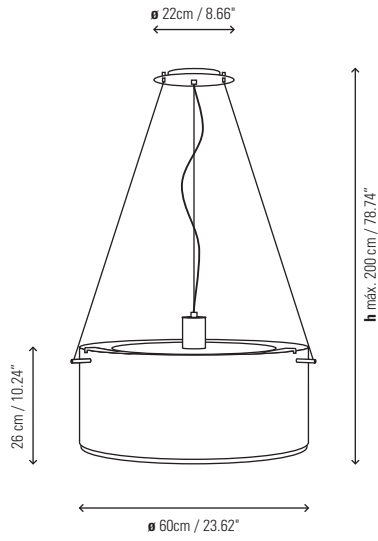

4132812U MATTE BLACK-NICKEL

Black aluminum shade  
White PVC interior B1 Flame Resistant  
Upper aluminum diffuser included  
Bottom glass diffuser included

Adjustable tensor wire



**FAMILY**

PAG. 52 52 108 228 266



**FINISHING**

SATIN NICKEL MATTE BLACK

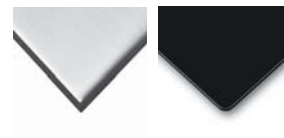





**DANONA - 1 LUZ**  
PENDANT LAMP



1 x 100 W A-19 E-26

1 x 18 W twist lock GU24 self ballasted lamp

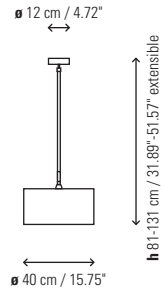

- 4123105U SATIN NICKEL
- 4123160U NICKEL DARK LEATHER
- 4123161U NICKEL CARAMEL LEATHER
  
- 4123105GU SATIN NICKEL / GU24
- 4123160GU NICKEL DARK LEATHER / GU24
- 4123161GU NICKEL CARAMEL LEATHER / GU24

Lampshade 15.75" x 8.66" x 15.75"

- P-416U COTTON
- P-420U WHITE TRANSLUCENT RIBBON
- P-421U CREAM TRANSLUCENT RIBBON

The shade includes upper diffuser

**DANONA - 3 LUCES**  
PENDANT LAMP



3 x 100 W A-19 E-26

3 x 18 W twist lock GU24 self ballasted lamp

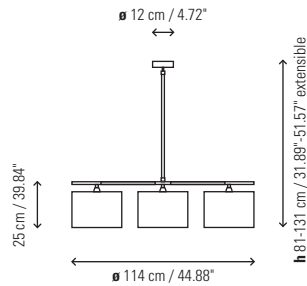

- 4323105U SATIN NICKEL
- 4323160U NICKEL DARK LEATHER
- 4323161U NICKEL CARAMEL LEATHER
  
- 4323105GU SATIN NICKEL / GU24
- 4323160GU NICKEL DARK LEATHER / GU24
- 4323161GU NICKEL CARAMEL LEATHER / GU24

Lampshade 10.63" x 7.09" x 10.63"

- P-150U COTTON
- P-005CU CREAM TRANSLUCENT RIBBON
- P-006CU WHITE TRANSLUCENT RIBBON



**FAMILY**

PAG. 96 96 212 212 246

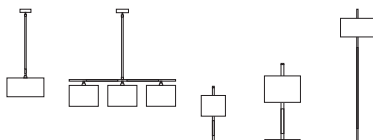

**FINISHING**

SATIN NICKEL DARK LEATHER CARAMEL LEATHER COTTON CREAM RIBBON WHITE RIBBON

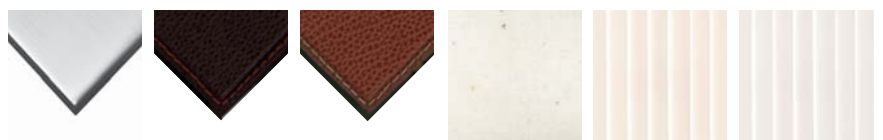





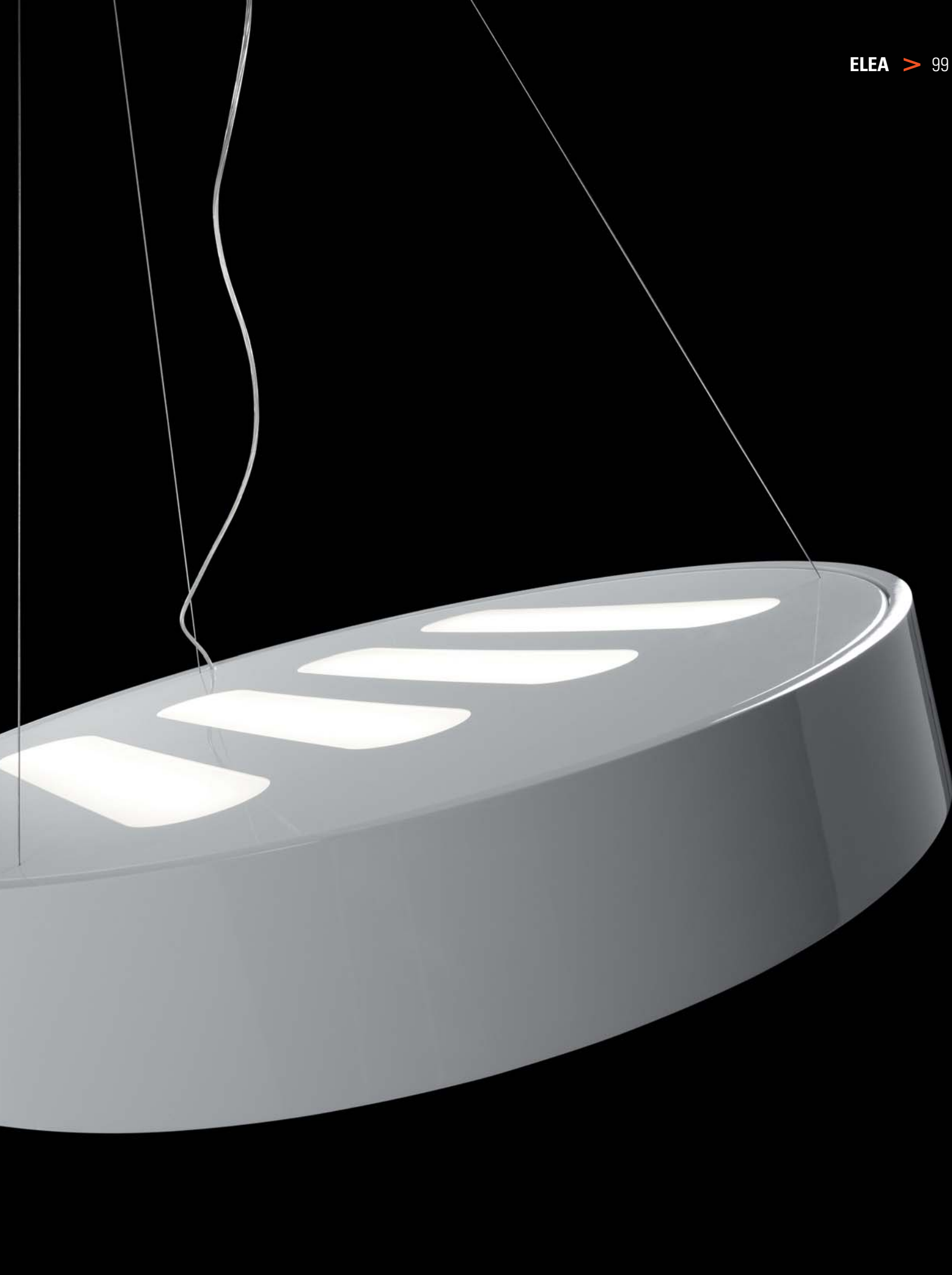

**ELEA - 02**  
PENDANT LAMP



4 x 60 W A-15 E-26

4 x 20 W T4 E-26 self ballasted lamp

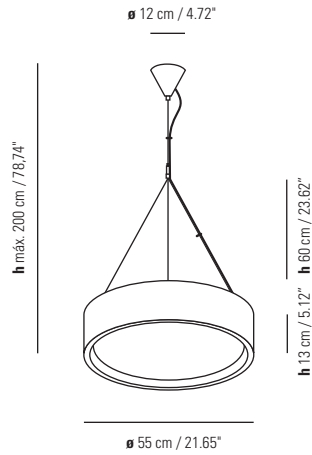

- 410232401U WHITE BRILLIANT LACQUER
- 410232423U BLACK BRILLIANT LACQUER
- 410232422U RED BRILLIANT LACQUER

Finishing: brilliant lacquer finish  
Material: Polyurethane  
Optical glass diffuser

**ELEA - 03 / DIMABLE**  
PENDANT LAMP



4 x 55 W 2G11

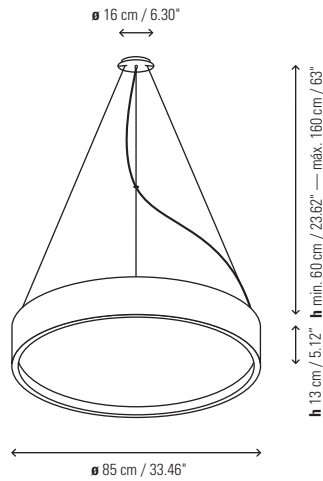

- 410332401U WHITE BRILLIANT LACQUER
- 410332423U BLACK BRILLIANT LACQUER
- 410332422U RED BRILLIANT LACQUER

- D410332401U DIMMING BALLAST-WHITE BRILLIANT LACQUER
- D410332423U DIMMING BALLAST-BLACK BRILLIANT LACQUER
- D410332422U DIMMING BALLAST-RED BRILLIANT LACQUER

DALI ballast  
Brilliant lacquer finish  
Material: Polyurethane  
Optical glass diffuser

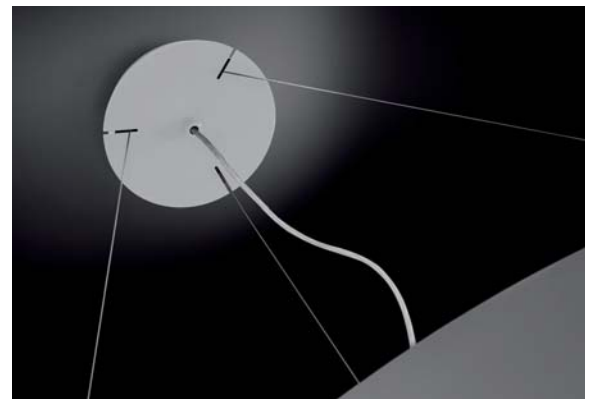

**FINISHING**

RED LACQUER      WHITE LACQUER      BLACK LACQUER







**BIG FORMAT**

Hotel Vincci Bit / Barcelona





**ELIPSE - 30**  
PENDANT LAMP



2 x 20 W T4 E-26

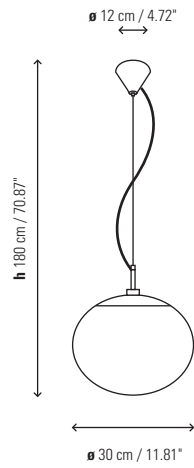

4032301U BALL 30 - WHITE  
4032305U BALL 30 - NICKEL

*Polyethylene globe of medium density and UV/light protection.*

**ELIPSE - 50**  
PENDANT LAMP



2 x 29 W T4 E-26

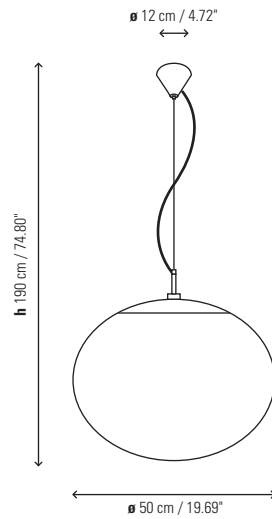

4132301U BALL 50 - WHITE  
4132305U BALL 50 - NICKEL

*Polyethylene globe of medium density and UV/light protection.*









**GLO**  
PENDANT LAMP



2 x 20 W T4 E-26

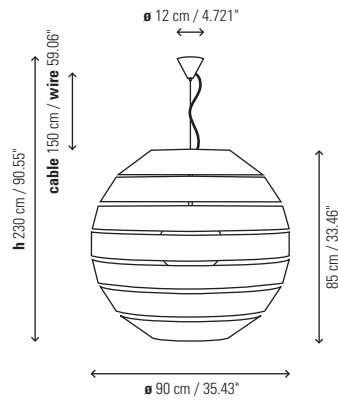

- 322P702U NICKEL-WHITE TRANSLUCENT RIBBON
- 322P703U NICKEL-CREAM TRANSLUCENT RIBBON
- 322P704U NICKEL-RED TRANSLUCENT RIBBON

Adjustable tensor wire  
 Transparent wire  
 Light source is protected by a polyethylene globe



**FINISHING**

SATIN NICKEL      WHITE RIBBON      CREAM RIBBON      RED RIBBON





**BIG FORMAT**







**HARDY**  
PENDANT LAMP



1 x 4 W GU10 LED

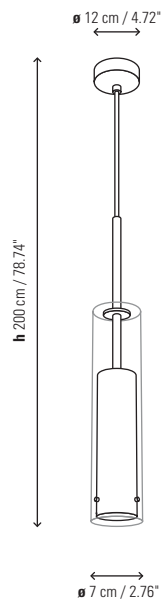

- 4131206U CHROME GLASS
- 4131221U WHITE GLASS
- 4131299U GOLD GLASS

*Led bulb included*

*Adjustable wire*

*Material: Borosilicate glass*

**FINISHING**

BRILLIANT CHROME

WHITE

GOLD

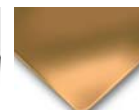







**INARI**  
PENDANT LAMP



3 x 60 W A-15 E-26

3 x 13 W twist lock GU24 self ballasted lamp

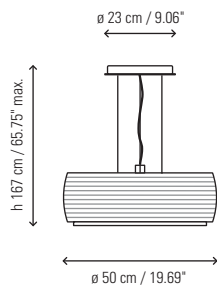

- 4120205U NICKEL-OPAL GLASS
- 4120206U CHROME-OPAL GLASS

- 4120205GU NICKEL-OPAL GLASS / GU24
- 4120206GU CHROME-OPAL GLASS / GU24

*Due to the nature of the hand blown cristal, natural variations should be expected and will not be considered an imperfection.*

**FAMILY**

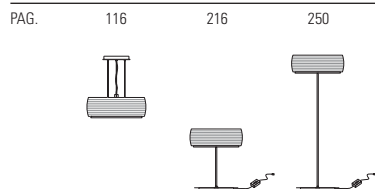

**FINISHING**

BRILLIANT CHROME SATIN NICKEL OPAL GLASS



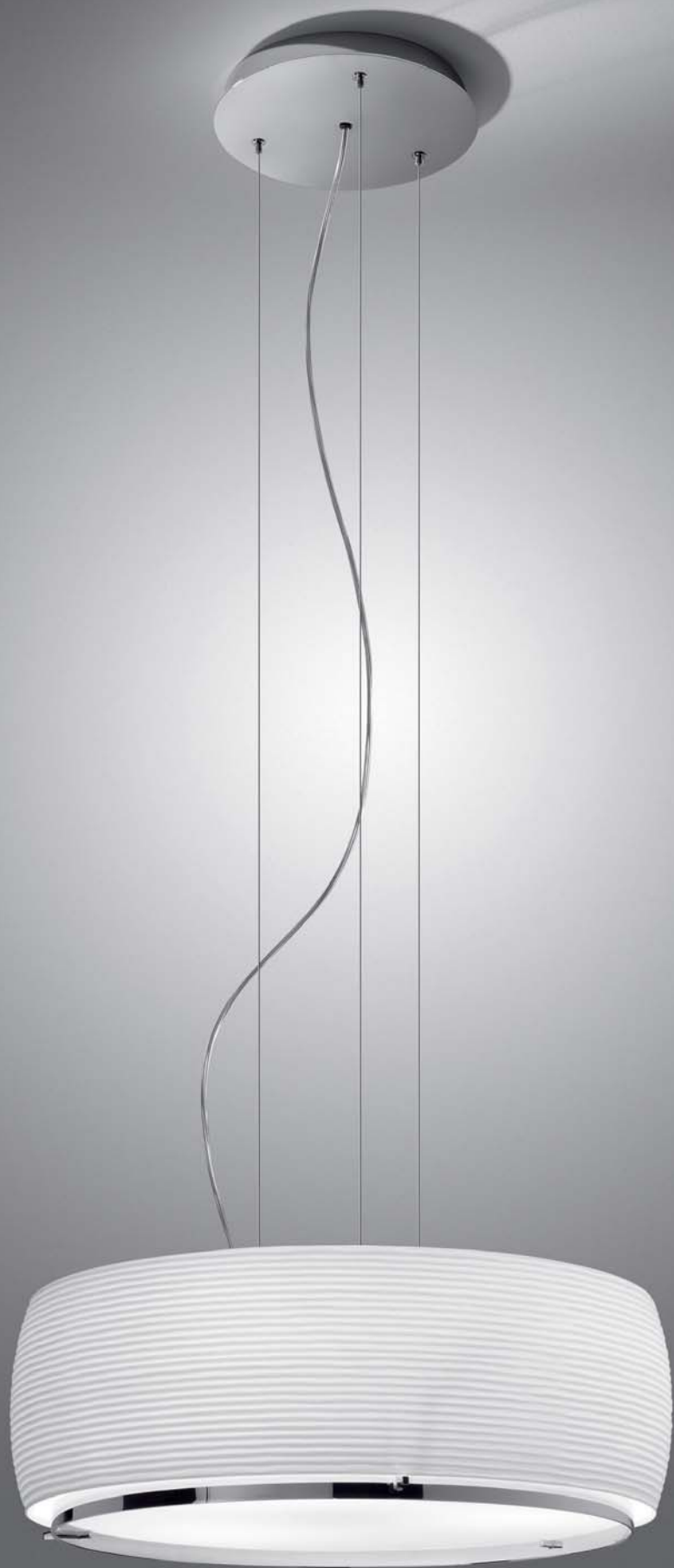







**LÁMPARA XVIII**  
PENDANT LAMP



18 x 60 W A-15 E-26

18 x 13 W twist lock GU24 self ballasted lamp

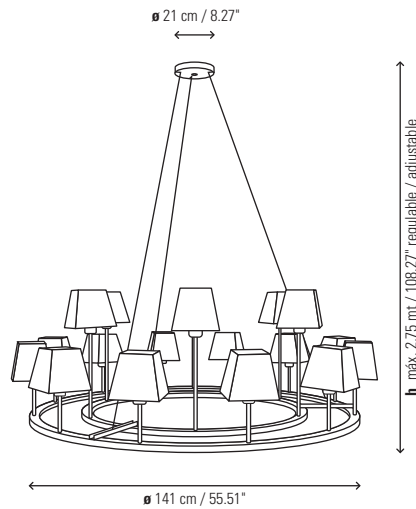

4610306U GREY SILVER-CHROME  
4610304U GRAPHITE BROWN-NICKEL

4610306GU GREY SILVER-CHROME / GU24  
4610304GU GRAPHITE BROWN-NICKEL / GU24

With 2 lighting-mood positions

Adjustable height

For easier installation, available with tensor wires including interior ball-and-socket joints

Silver wire

Square lampshades 5.91" x 5.12" x 3.94"

P-640U WHITE COTTON  
P-641U WHITE TRANSLUCENT RIBBON  
P-642U CREAM TRANSLUCENT RIBBON  
P-643U RED TRANSLUCENT RIBBON

Cone-shaped shades 7.09" x 5.91" x 4.72"

P-750U COTTON  
P-751U WHITE TRANSLUCENT RIBBON  
P-752U CREAM TRANSLUCENT RIBBON  
P-753U RED TRANSLUCENT RIBBON



**FINISHING**

GRAPHITE BROWN    GREY SILVER    COTTON    WHITE RIBBON    CREAM RIBBON    RED RIBBON











**LUA - 1 LUZ**  
PENDANT LAMP

-   2 x 100 W A-19 E-26
-  2 x 14 W T4 E-26

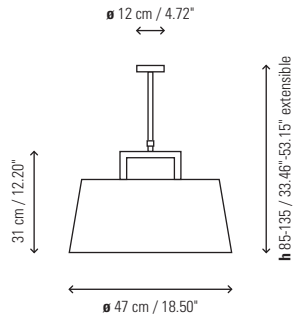

- 4122904U BLACK IRON
- 4122905U SATIN NICKEL
- 4122960U NICKEL DARK LEATHER
- 4122961U NICKEL CARAMEL LEATHER

Lampshade 18.50" x 8.27" x 15.75"

- P-160CU COTTON
- P-183CU CREAM TRANSLUCENT RIBBON
- P-184CU WHITE TRANSLUCENT RIBBON

The shade includes upper diffuser

**LUA - 2 LUCES**  
PENDANT LAMP

-   2 x 100 W A-19 E-26
-  2 x 14 W T4 E-26

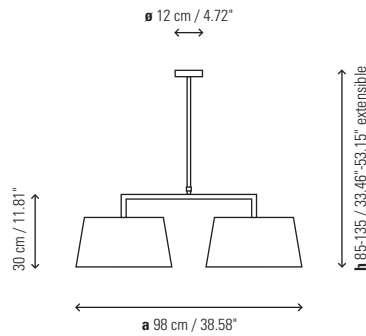

- 4222904U BLACK IRON
- 4222905U SATIN NICKEL
- 4222960U NICKEL DARK LEATHER
- 4222961U NICKEL CARAMEL LEATHER

Lampshade 14.96" x 7.87" x 11.81"

- P-163CU COTTON
- P-167CU CREAM TRANSLUCENT RIBBON
- P-168CU WHITE TRANSLUCENT RIBBON

The shade includes upper diffuser

**FINISHING**

- SATIN NICKEL
- BLACK IRON
- DARK LEATHER
- CARAMEL LEATHER
- COTTON
- CREAM RIBBON
- WHITE RIBBON

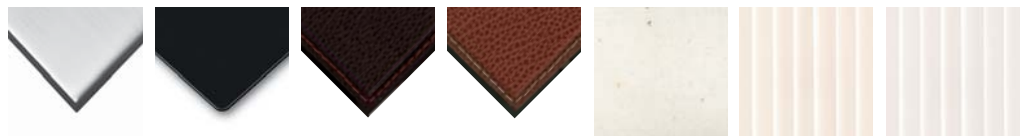



**MAR**

PENDANT LAMP



3 x 60 W A-15 E-26

3 x 13 W twist lock GU24 self ballasted lamp

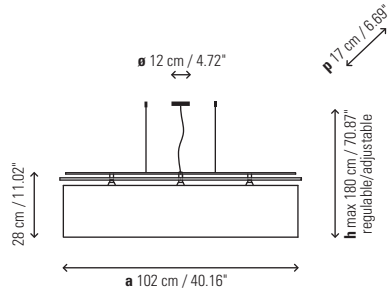

- 4324405TU NICKEL TRANSPARENT WIRE
- 4324405RU NICKEL RED WIRE
- 4324460U DARK LEATHER TRANSPARENT WIRE
- 4324461U CAMEL LEATHER TRANSPARENT WIRE

- 4324405TGU NICKEL TRANSPARENT WIRE / GU24
- 4324405RGU NICKEL RED WIRE / GU24
- 4324460GU DARK LEATHER TRANSPARENT WIRE / GU24
- 4324461GU CAMEL LEATHER TRANSPARENT WIRE / GU24

Rectangular lampshade 39.37" x 6.69". Diffuser included

- P-521U CREAM TRANSLUCENT RIBBON
- P-522U WHITE TRANSLUCENT RIBBON
- P-523U RED TRANSLUCENT RIBBON
- P-524U COTTON

Diffuser PVC included



**FINISHING**

- SATIN NICKEL    DARK LEATHER    CAMEL LEATHER    COTTON    CREAM RIBBON    WHITE RIBBON    RED RIBBON







**MAXI - 01**  
PENDANT LAMP



- 4 x 60 W A-15 E-26
- 4 x 13 W twist lock GU24 self ballasted lamp

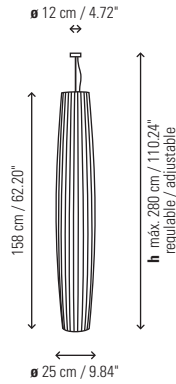

- 43195TOPU ELECTRICAL UPPER INSTALLATION
- 4319505U ELECTRICAL BOTTOM INSTALLATION

- 43195TOPGU ELECTRICAL UPPER INSTALLATION / GU24
- 4319505GU ELECTRICAL BOTTOM INSTALLATION / GU24

Lampshade 62.20" X 9.84"

- P-507TU TOP CREAM RIBBON
- P-508TU TOP WHITE RIBBON
- P-507IU BOTTOM INST. CREAM RIBBON
- P-508IU BOTTOM INST. WHITE RIBBON

Adjustable tensor wire  
Nickel canopy (only for upper installation)  
Eco Classic bulbs included

Maxi 01 / Maxi 02 pendant lamp comes in two versions: with upper installation and with bottom installation.

**MAXI - 02**  
PENDANT LAMP



- 4 x 60 W A-15 E-26
- 4 x 13 W twist lock GU24 self ballasted lamp

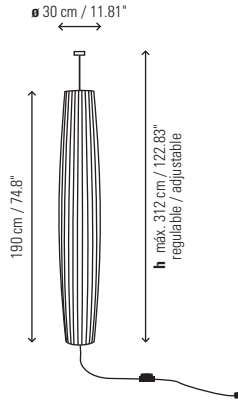

- 44195TOPU ELECTRICAL UPPER INSTALLATION
- 4419505U ELECTRICAL BOTTOM INSTALLATION

- 44195TOPGU ELECTRICAL UPPER INSTALLATION / GU24
- 4419505GU ELECTRICAL BOTTOM INSTALLATION / GU24

Lampshade 74.8" X 11.81"

- P-506TU TOP CREAM RIBBON
- P-509TU TOP WHITE RIBBON
- P-506IU BOTTOM INST. CREAM RIBBON
- P-509IU BOTTOM INST. WHITE RIBBON

Adjustable tensor wire  
Nickel canopy (only for upper installation)  
Eco Classic bulbs included

Maxi 01 / Maxi 02 pendant lamp comes in two versions: with upper installation and with bottom installation.

**MAXI - 03 / DIMABLE**  
PENDANT LAMP



- 2 x 54 W T5

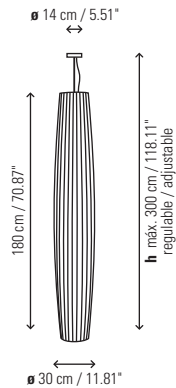

- 4303195TOPU ELECTRICAL UPPER INSTALLATION

Lampshade 70.87" X 11.81"

- P-754TU TOP CREAM RIBBON
- P-755TU TOP WHITE RIBBON

Adjustable tensor wire  
Nickel canopy  
Supply fluorescent tubes already installed inside the luminaire.

DALI ballast

**FAMILY**

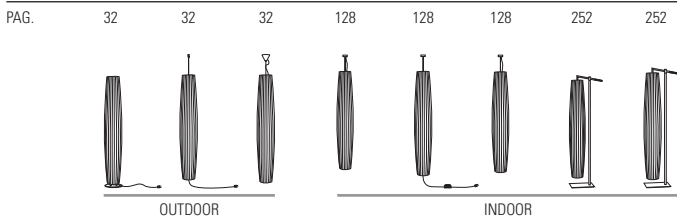

**FINISHING**

- SATIN NICKEL
- CREAM RIBBON
- WHITE RIBBON









**MEI - 38**  
PENDANT LAMP



1 x 60 W A-15 E-26

1 x 14 W T4 E-26 self ballasted lamp

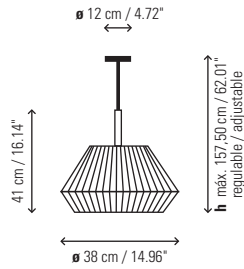

- 4219903U BROWN IRON
- 4219904U BLACK IRON
- 4219905U SATIN NICKEL

Lampshade 12.60" x 7.48" x 7.87"  
Diffuser PVC included  
Transparent connection

- P-495CU RED TRANSLUCENT RIBBON
- P-504CU CREAM TRANSLUCENT RIBBON
- P-505CU WHITE TRANSLUCENT RIBBON

**MEI - 60**  
PENDANT LAMP



1 x 100 W A-19 E-26

1 x 20 W T4 E-26 self ballasted lamp

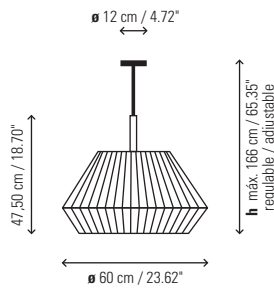

- 4119903U BROWN IRON
- 4119904U BLACK IRON
- 4119905U SATIN NICKEL

Lampshade 19.69" x 12.20" x 11.81"  
Diffuser PVC included  
Transparent connection

- P-496CU BLACK TRANSLUCENT RIBBON
- P-501CU RED TRANSLUCENT RIBBON
- P-502CU CREAM TRANSLUCENT RIBBON
- P-503CU WHITE TRANSLUCENT RIBBON

**MEI - 90**  
PENDANT LAMP



3 x 100 W A-19 E-26

3 x 20 W T4 E-26 self ballasted lamp

**BIG FORMAT**

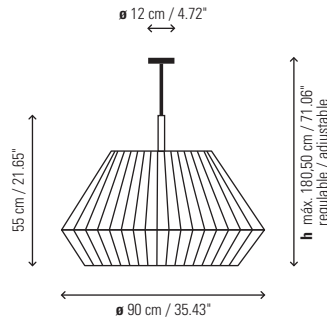

- 4419903U BROWN IRON
- 4419904U BLACK IRON
- 4419905U SATIN NICKEL

Lampshade 31.50" x 16.34" x 13.78"  
Diffuser PVC included  
Transparent connection

- P-490CU WHITE TRANSLUCENT RIBBON
- P-491CU CREAM TRANSLUCENT RIBBON
- P-492CU RED TRANSLUCENT RIBBON
- P-493CU BLACK TRANSLUCENT RIBBON

**FINISHING**

BROWN IRON      BLACK IRON      SATIN NICKEL



CREAM RIBBON      WHITE RIBBON      RED RIBBON      BLACK RIBBON



**FAMILY**

PAG. 132 132 132 136 136

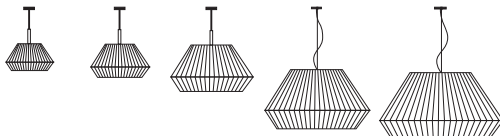







Danone / Barcelona







**MEI - 125**  
PENDANT LAMP

-   5 x 100 W A-19 E-26
-  5 x 20 W T4 E-26 self ballasted lamp

**BIG FORMAT**

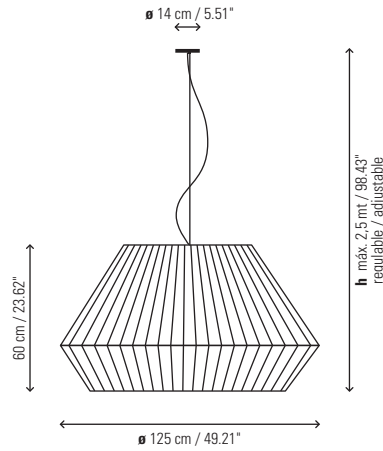



- 4719903U *BROWN IRON*
- 4719904U *BLACK IRON*
- 4719905U *SATIN NICKEL*

*Lampshade 49.21" x 23.62" x 18.90"*  
*Diffuser PVC included*  
*Transparent connection*

- P-720CU *WHITE TRANSLUCENT RIBBON*
- P-721CU *CREAM TRANSLUCENT RIBBON*
- P-722CU *RED TRANSLUCENT RIBBON*
- P-723CU *BLACK TRANSLUCENT RIBBON*

**MEI - 150**  
PENDANT LAMP

-   6 x 100 W A-19 E-26
-  6 x 20 W T4 E-26 self ballasted lamp

**BIG FORMAT**

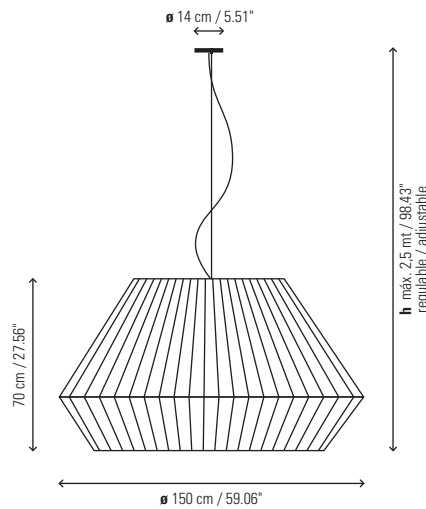

- 4619903U *BROWN IRON*
- 4619904U *BLACK IRON*
- 4619905U *SATIN NICKEL*

*Lampshade 59.06" x 27.56" x 23.23"*  
*Diffuser PVC included*  
*Transparent connection*  
*Porcelain lampholders*

- P-590CU *WHITE TRANSLUCENT RIBBON*
- P-591CU *CREAM TRANSLUCENT RIBBON*
- P-592CU *RED TRANSLUCENT RIBBON*
- P-593CU *BLACK TRANSLUCENT RIBBON*

**FINISHING**

*BROWN IRON      BLACK IRON      SATIN NICKEL*



*CREAM RIBBON      WHITE RIBBON      RED RIBBON      BLACK RIBBON*



**FAMILY**

PAG. 132 132 132 136 136

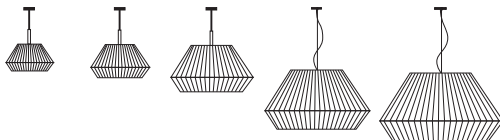



**BIG FORMAT**

**MEI - 100**  
PENDANT LAMP



3 x 60 W A-15 E-26

3 x 13 W twist lock GU24 self ballasted lamp

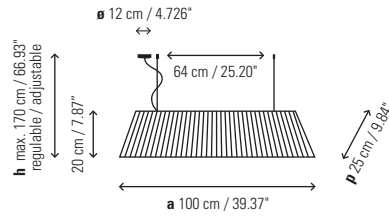

- 4319903U BROWN IRON
- 4319904U BLACK IRON
- 4319905U SATIN NICKEL

- 4319903GU BROWN IRON / GU24
- 4319904GU BLACK IRON / GU24
- 4319905GU SATIN NICKEL / GU24

Rectangular lampshade 39.37" x 9.84"  
Diffuser PVC included

- P-497CU CREAM TRANSLUCENT RIBBON
- P-498CU COTTON
- P-499CU LINEN
- P-584CU WHITE TRANSLUCENT RIBBON
- P-585CU RED TRANSLUCENT RIBBON
- P-586CU BLACK TRANSLUCENT RIBBON

Adjustable tensor wire

**MEI - 120**  
PENDANT LAMP



5 x 60 W A-15 E-26

5 x 13 W twist lock GU24 self ballasted lamp

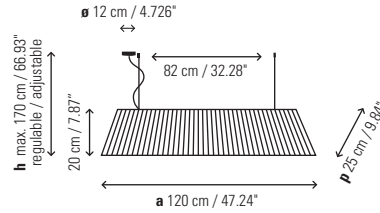

- 4519903U BROWN IRON
- 4519904U BLACK IRON
- 4519905U SATIN NICKEL

- 4519903GU BROWN IRON / GU24
- 4519904GU BLACK IRON / GU24
- 4519905GU SATIN NICKEL / GU24

Rectangular lampshade 47.24" x 9.84"  
Diffuser PVC included

- P-510CU CREAM TRANSLUCENT RIBBON
- P-511CU COTTON
- P-512CU LINEN
- P-514CU WHITE TRANSLUCENT RIBBON
- P-522CU RED TRANSLUCENT RIBBON
- P-523CU BLACK TRANSLUCENT RIBBON

Adjustable tensor wire

**MEI - 180**  
PENDANT LAMP



6 x 60 W A-15 E-26

6 x 15 W T3 E-26 self ballasted lamp

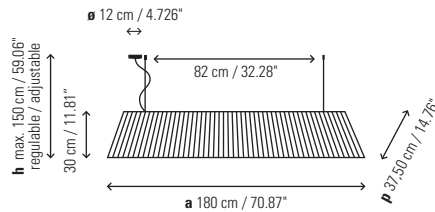

- 430319903U BROWN IRON
- 430319904U BLACK IRON
- 430319905U SATIN NICKEL

Rectangular lampshade 70.87" x 14.76"  
Diffuser PVC included

- P-756CU CREAM TRANSLUCENT RIBBON
- P-757CU COTTON
- P-758CU LINEN
- P-759CU WHITE TRANSLUCENT RIBBON
- P-760CU RED TRANSLUCENT RIBBON
- P-761CU BLACK TRANSLUCENT RIBBON

Adjustable tensor wire

**BIG FORMAT**

**FINISHING**

BROWN IRON    BLACK IRON    SATIN NICKEL    LINEN    COTTON    CREAM RIBBON    WHITE RIBBON    RED RIBBON    BLACK RIBBON









**MEI OVAL**

PENDANT LAMP



3 x 60 W A-15 E-26

3 x 14 W T4 E-26 self ballasted lamp

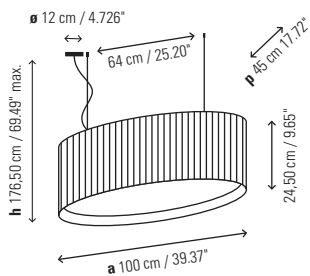

- 4319903U BROWN IRON
- 4319904U BLACK IRON
- 4319905U SATIN NICKEL

Oval lampshade 39.37" x 9.65" x 17.32"

- P-545CU WHITE TRANSLUCENT RIBBON
- P-546CU CREAM TRANSLUCENT RIBBON
- P-547CU BLACK TRANSLUCENT RIBBON
- P-548CU WHITE COTTON

Diffuser PVC included  
Adjustable tensor wire



**FAMILY**

PAG. 66 142 220 254

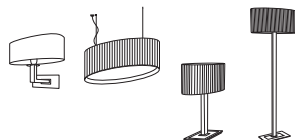

**FINISHING**

BROWN IRON BLACK IRON SATIN NICKEL WHITE RIBBON CREAM RIBBON BLACK RIBBON COTTON WHITE







**MOS - 01**  
PENDANT LAMP



3 x 60 W A-15 E-26

3 x 14 W T4 E-26 self ballasted lamp

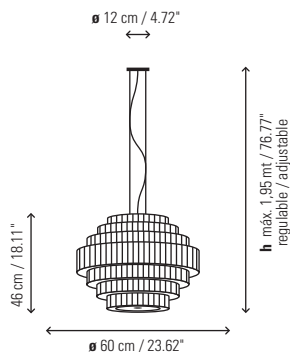

- 224P617U WHITE TRANSLUCENT RIBBON
- 224P618U CREAM TRANSLUCENT RIBBON
- 224P619U RED TRANSLUCENT RIBBON

Diffuser white opal glass included  
Satin nickel  
Transparent connection  
Adjustable tensor wire  
Safety tensor wire

**MOS - 02**  
PENDANT LAMP



5 x 60 W A-15 E-26

5 x 14 W T4 E-26 self ballasted lamp

OPTIONAL LED  
Led source available / Consult

• Led: 65 W  
Lumens: 4.750 lm  
Degrees Kelvin: 2.600°

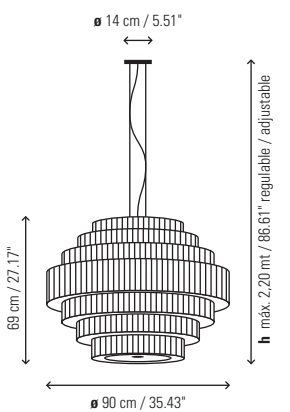

- 224P622U WHITE TRANSLUCENT RIBBON
- 224P623U CREAM TRANSLUCENT RIBBON
- 224P624U RED TRANSLUCENT RIBBON

- D224P622LU LED REGULABLE DALI WHITE TRANSLUCENT RIBBON
- D224P623LU LED REGULABLE DALI CREAM TRANSLUCENT RIBBON
- D224P624LU LED REGULABLE DALI RED TRANSLUCENT RIBBON

Diffuser white opal glass included  
Satin nickel  
Transparent connection  
Adjustable tensor wire  
Safety tensor wire

**MOS - 03**  
PENDANT LAMP



6 x 100 W A-19 E-26

6 x 20 W T4 E-26 self ballasted lamp

**MOS - 03**

OPTIONAL LED  
Led source available / Consult

• Led: 80 W  
Lumens: 5.830 lm  
Degrees Kelvin: 2600°

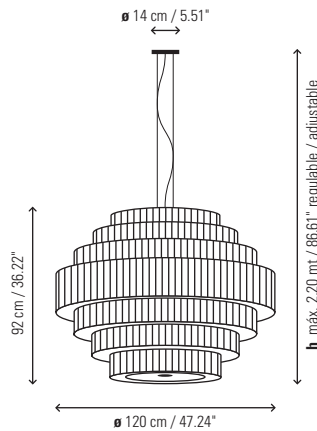

- 224P621U WHITE TRANSLUCENT RIBBON
- 224P625U CREAM TRANSLUCENT RIBBON
- 224P626U RED TRANSLUCENT RIBBON

- D224P621LU LED REGULABLE DALI WHITE TRANSLUCENT RIBBON
- D224P625LU LED REGULABLE DALI CREAM TRANSLUCENT RIBBON
- D224P626LU LED REGULABLE DALI RED TRANSLUCENT RIBBON

**BIG FORMAT**

**FINISHING**

CREAM RIBBON    WHITE RIBBON    RED RIBBON







**BIG FORMAT**

**Poliform / Italy**



**BIG FORMAT**

**Hostal Empúries / L'Escala**







**OLIVER**  
PENDANT LAMP



1 x 15 W A-19 E-26  
self ballasted lamp

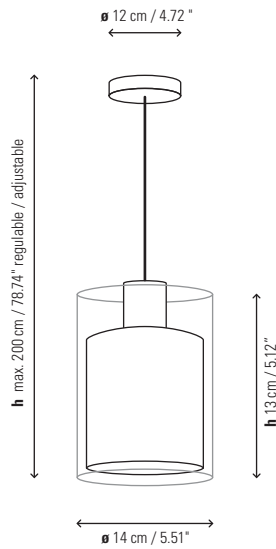

4131306U CHROME

Lampshade 7.48"x 5.51"

- P-734CU WHITE TRANSLUCENT RIBBON
- P-735CU CREAM TRANSLUCENT RIBBON
- P-736CU RED TRANSLUCENT RIBBON
- P-737CU WHITE COTTON
- P-738CU BLACK COTTON
- P-739CU WHITE-ORANGE INNER
- P-740CU BLACK-ORANGE INNER

Bulb included

Material: Borosilicate glass

Transparent connection

Adjustable wire



**FAMILY**

PAG. 150 188

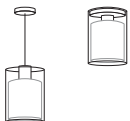

**FINISHING**

BRILLIANT CHROME WHITE RIBBON CREAM RIBBON RED RIBBON COTTON WHITE BLACK COTTON COTTON WHITE BLACK COTTON









# consell farmacèutic

ESPECIALTATS / HOMEOPÀTIA / PRODUCTES NATURALS





**SIAM - 4 LUCES**  
PENDANT LAMP



12 x 20 W T4 E-26 self ballasted lamp

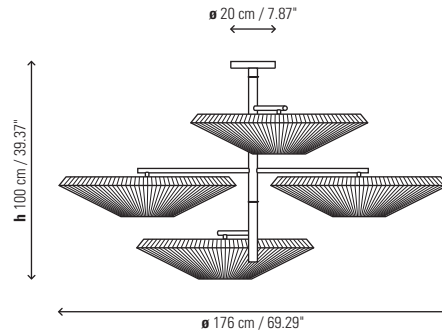

4432005U SATIN NICKEL  
4432001U WHITE 9010

Lampshade: 80x18 cm ( x4 UNITS )

P-686CU WHITE TRANSLUCENT RIBBON  
P-687CU CREAM TRANSLUCENT RIBBON  
P-688CU RED TRANSLUCENT RIBBON

Methacrylate diffuser

Place horizontal arms on the desired position and block structure to fix arms for safety reasons.

**SIAM - 6 LUCES**  
PENDANT LAMP



18 x 20 W T4 E-26

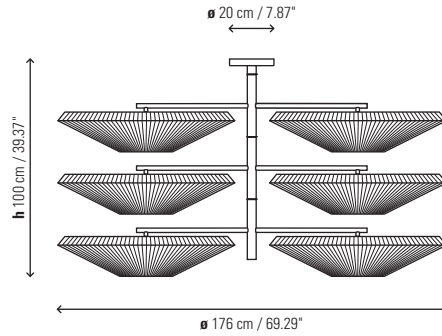

4632005U SATIN NICKEL  
4632001U WHITE 9010

Lampshade: 80x18 cm ( x 6 UNITS )

P-686CU WHITE TRANSLUCENT RIBBON  
P-687CU CREAM TRANSLUCENT RIBBON  
P-688CU RED TRANSLUCENT RIBBON

Methacrylate diffuser

Place horizontal arms on the desired position and block structure to fix arms for safety reasons.

**FAMILY**

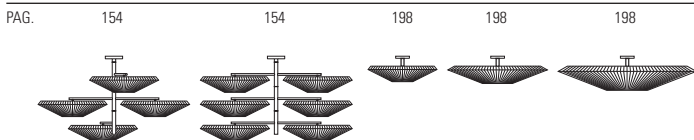

**FINISHING**









**SILANTRA - 07**  
PENDANT LAMP



2 x 54 W T5

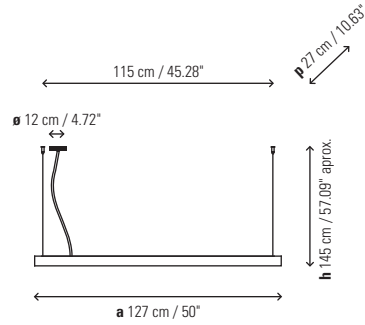

7245537U ELECTRONIC BALLAST / CREAM TRANSLUCENT RIBBON  
7245538U ELECTRONIC BALLAST / WHITE TRANSLUCENT RIBBON

D7245537U DIMMING BALLAST / CREAM TRANSLUCENT RIBBON  
D7245538U DIMMING BALLAST / WHITE TRANSLUCENT RIBBON

Polished aluminium  
Lampshade 50" x 10.63"

Photometry **CE** available

**DALI SYSTEM:**  
Digital interface to control electrical dimming components.

**PUSH SYSTEM-DIGITAL DIMMER SYSTEM:**  
Bipolar interface to electrical ballasts regulating luminous intensity through push buttons.

**FAMILY**

PAG. 74 76 76 76 158

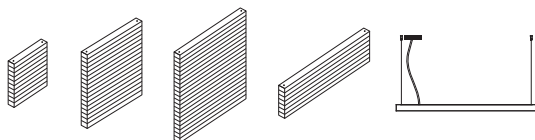

**FINISHING**

POLISHED ALUMINIUM CREAM RIBBON WHITE RIBBON











**TAU - 1 LUZ**  
PENDANT LAMP



3 x 60 W A-15 E-26

3 x 14 W T4 E-26 self ballasted lamp

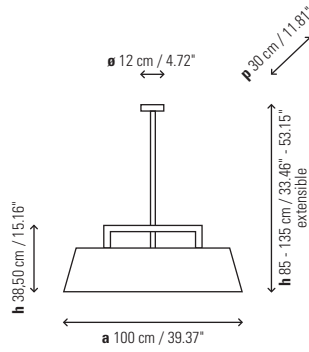

- 4323905U SATIN NICKEL
- 4323960U NICKEL DARK LEATHER
- 4323961U NICKEL CARAMEL LEATHER

Rectangular lampshade 39.37" x 11.81" x 31.69"

With lower PVC diffuser

- P-482CU LINEN
- P-483CU COTTON
- P-683U WHITE TRANSLUCENT RIBBON
- P-684U CREAM TRANSLUCENT RIBBON

**FAMILY**

PAG. 162 234 234 258



**FINISHING**

SATIN NICKEL DARK LEATHER CARAMEL LEATHER LINEN COTTON CREAM RIBBON WHITE RIBBON





**TEKNO - LP1**  
PENDANT LAMP



2 x 39 W T5

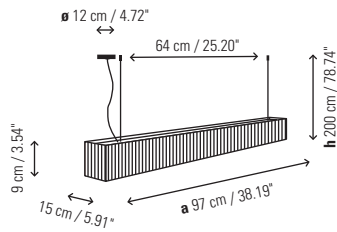

- 4218801U WHITE TRANSLUCENT RIBBON
- 4218802U CREAM TRANSLUCENT RIBBON
- 4218803U WHITE COTTON
- 4218804U RED TRANSLUCENT RIBBON
- 4218805U BLACK TRANSLUCENT RIBBON

*Due to translucent ribbon's nature, light colour shade may reflect the inner structure.*

Optical glass diffuser

Dimming optional ballast: to be consulted.

Photometry **CE** available

**TEKNO - LP2**  
PENDANT LAMP



2 x 54 W T5

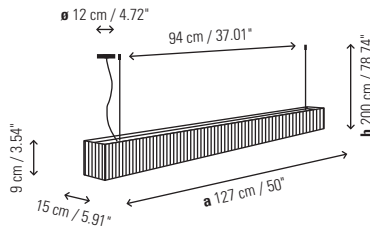

- 4318801U WHITE TRANSLUCENT RIBBON
- 4318802U CREAM TRANSLUCENT RIBBON
- 4318803U WHITE COTTON
- 4318804U RED TRANSLUCENT RIBBON
- 4318805U BLACK TRANSLUCENT RIBBON

*Due to translucent ribbon's nature, light colour shade may reflect the inner structure.*

Optical glass diffuser

Dimming optional ballast: to be consulted.

Photometry **CE** available



**FINISHING**

CREAM RIBBON    WHITE RIBBON    COTTON WHITE    RED RIBBON    BLACK RIBBON

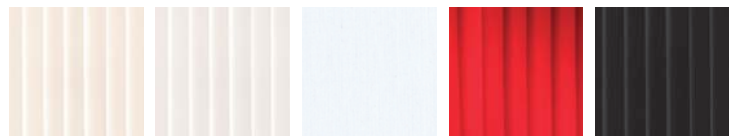



**TEKNO - C**  
PENDANT LAMP



2 x 100 W A-19 E-26

2 x 14 W T4 E-26 self ballasted lamp

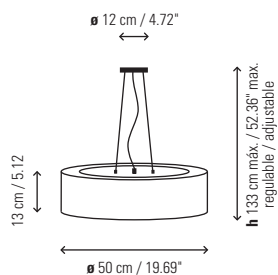

- 4118860U NICKEL DARK LEATHER
- 4118861U NICKEL CARAMEL LEATHER

Adjustable tensor wire  
Transparent connection

Optical glass diffuser

**TEKNO - CP**  
PENDANT LAMP



2 x 100 W A-19 E-26

2 x 14 W T4 E-26 self ballasted lamp

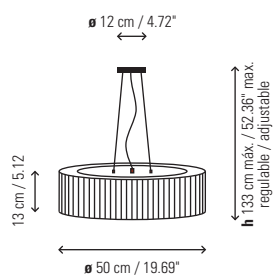

- 4118856U NICKEL WHITE COTTON
- 4118857U NICKEL WHITE TRANSLUCENT RIBBON
- 4118858U NICKEL CREAM TRANSLUCENT RIBBON
- 4118859U NICKEL RED TRANSLUCENT RIBBON

Adjustable tensor wire  
Red wire connection

Photometry available



**FINISHING**

SATIN NICKEL    DARK LEATHER    CARAMEL LEATHER    COTTON WHITE    WHITE RIBBON    CREAM RIBBON    RED RIBBON

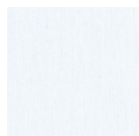
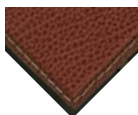
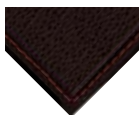
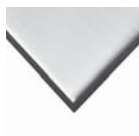





**TWINS - 01**  
PENDANT LAMP



1 x 40 W Globe G25  $\phi$  3 1/8 E-26

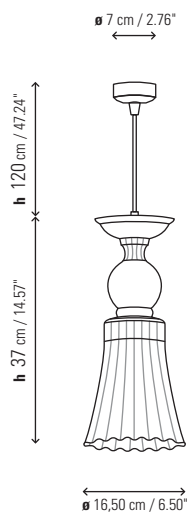

410131106U BLOWN GLASS TRANSPARENT WIRE  
410131122U BLOWN GLASS RED WIRE

Led bulb included

**TWINS - 02**  
PENDANT LAMP



1 x 40 W Globe G25  $\phi$  3 1/8 E-26

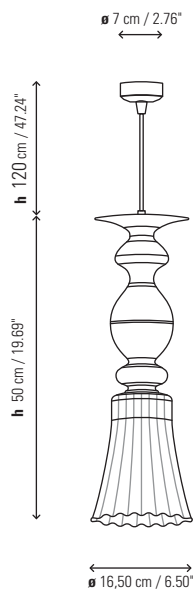

410231106U BLOWN GLASS TRANSPARENT WIRE  
410231122U BLOWN GLASS RED WIRE

Led bulb included

Material: Blown glass

Adjustable wire

Due to the nature of the hand blown cristal, natural variations should be expected and will not be considered an imperfection.

**FINISHING**

BRILLIANT CHROME RED CHROME

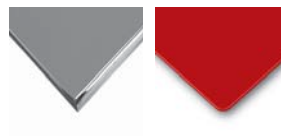







**URBAN - 01**

PENDANT LAMP



2 x 60 W A-15 E-26

2 x 14 W T4 E-26 self ballasted lamp

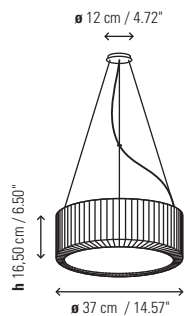

410132506BU CHROME-WHITE TRANSLUCENT RIBBON  
410132506CU CHROME-CREAM TRANSLUCENT RIBBON  
410132506RU CHROME-RED TRANSLUCENT RIBBON

Upper diffuser glass  
Lower diffuser glass + ring

**URBAN - 02**

CEILING



4 x 60 W A-15 E-26

4 x 14 W T4 E-26 self ballasted lamp

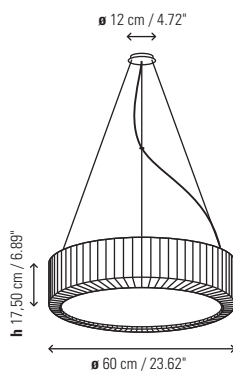

410232506BU CHROME-WHITE TRANSLUCENT RIBBON  
410232506CU CHROME-CREAM TRANSLUCENT RIBBON  
410232506RU CHROME-RED TRANSLUCENT RIBBON

Upper diffuser glass  
Lower diffuser glass + ring

**URBAN - 03**

CEILING



6 x 36 W 2G11

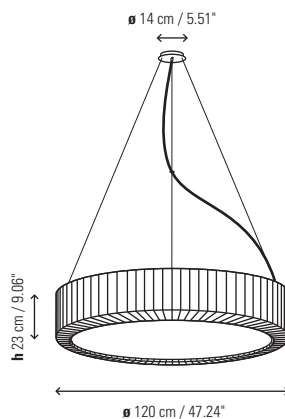

410332506BU CHROME-WHITE TRANSLUCENT RIBBON  
410332506CU CHROME-CREAM TRANSLUCENT RIBBON  
410332506RU CHROME-RED TRANSLUCENT RIBBON

D410332506BU DIMMING BALLAST/CHROME-WHITE TRANSLUCENT RIBBON  
D410332506CU DIMMING BALLAST/CHROME-CREAM TRANSLUCENT RIBBON  
D410332506RU DIMMING BALLAST/CHROME-RED TRANSLUCENT RIBBON

Methacrylate diffuser  
Lower diffuser methacrylate + ring

DALI ballast

**FAMILY**

PAG. 172 172 172 202 202 202

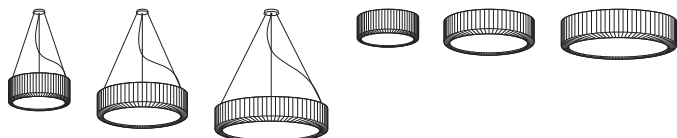

**FINISHING**

BRILLIANT CHROME CREAM RIBBON WHITE RIBBON RED RIBBON













# *CEILING LAMP*



**CALA**  
CEILING



4 x 14 W T4 E-26  
self ballasted lamp

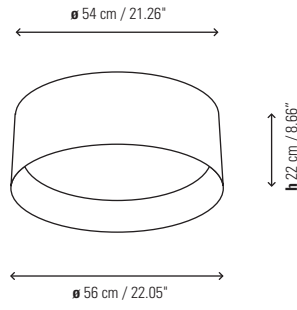

- 5132601 WHITE BRILLIANT LACQUER
- 5132623 BLACK BRILLIANT LACQUER
- 5132622 RED BRILLIANT LACQUER

Finishing: brilliant lacquer

Material: Polyurethane

Photometry **CE** available



**FAMILY**

PAG. 90 178

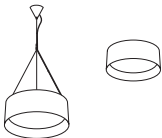

**FINISHING**

RED LACQUER WHITE LACQUER BLACK LACQUER









**ELEA - 02**  
CEILING



4 x 20 W T4 E-26  
self ballasted lamp

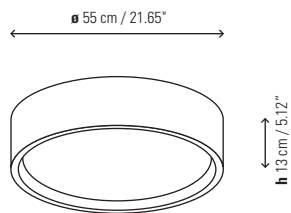

510232401U *WHITE BRILLIANT LACQUER*  
510232423U *BLACK BRILLIANT LACQUER*  
510232422U *RED BRILLIANT LACQUER*

*Finishing: brilliant lacquer*

*Material: Polyurethane*

*Optical glass diffuser*

**ELEA - 03 / DIMABLE**  
CEILING



4 x 55 W 2G11

**BIG FORMAT**

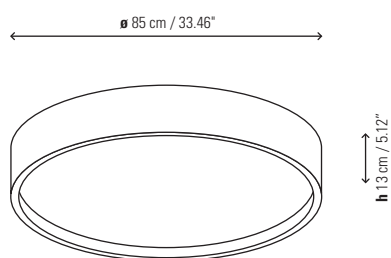

510332401U *WHITE BRILLIANT LACQUER*  
510332423U *BLACK BRILLIANT LACQUER*  
510332422U *RED BRILLIANT LACQUER*

D510332401U *DIMMING BALLAST-WHITE BRILLIANT LACQUER*

D510332423U *DIMMING BALLAST-BLACK BRILLIANT LACQUER*

D510332422U *DIMMING BALLAST-RED BRILLIANT LACQUER*

*Finishing: brilliant lacquer*

*Material: Polyurethane*

*Optical glass diffuser*

*DALI ballast*

**FINISHING**

RED LACQUER

WHITE LACQUER

BLACK LACQUER











**KUADRAT - F**

CEILING



1 x 40 W T5 Circular

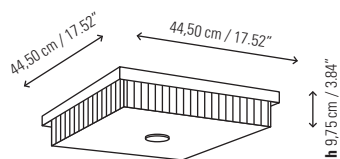

- 5015105FU SATIN NICKEL
- 5015106FU BRILLIANT CHROME
- 5015108FU GREY GRAPHITE

Inner cotton shade in polyester

- P-628U WHITE COTTON
- P-629U WHITE TRANSLUCENT RIBBON
- P-630U CREAM TRANSLUCENT RIBBON

Diffuser: optical matte glass diffuser

**KUADRAT - I**

CEILING



4 x 40 W A-15 E-12

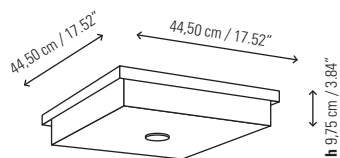

- 5015105IU SATIN NICKEL
- 5015106IU BRILLIANT CHROME
- 5015108IU GREY GRAPHITE

Inner cotton shade in polyester

- P-628U WHITE COTTON
- P-629U WHITE TRANSLUCENT RIBBON
- P-630U CREAM TRANSLUCENT RIBBON

Diffuser: optical matte glass diffuser

**FINISHING**

BRILLIANT CHROME    SATIN NICKEL    GREY GRAPHITE    WHITE COTTON    CREAM RIBBON    WHITE RIBBON





**OLIVER**  
CEILING



1 x 15 W A-19 E-26  
self ballasted lamp

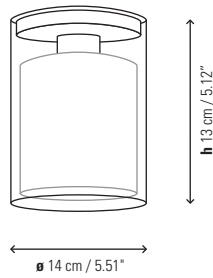

5131306U *CHROME*

Lampshade 7.48"x 5.51"

- P-734CU *WHITE TRANSLUCENT RIBBON*
- P-735CU *CREAM TRANSLUCENT RIBBON*
- P-736CU *RED TRANSLUCENT RIBBON*
- P-737CU *WHITE COTTON*
- P-738CU *BLACK COTTON*
- P-739CU *WHITE-ORANGE INNER*
- P-740CU *BLACK-ORANGE INNER*

*Bulb included*

*Material: Borosilicate glass*



**FAMILY**

PAG. 150 188

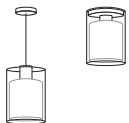

**FINISHING**

BRILLIANT CHROME WHITE RIBBON CREAM RIBBON RED RIBBON COTTON WHITE BLACK COTTON COTTON WHITE BLACK COTTON







dermofarmàcia | benestar



dietètica, herboristeria

CONTROL DE PES / PLANTES MEDICINALS / VITAMINES / NUTRACÈUT







**PLAFONET - 01**  
**FONDA EUROPA**

CEILING



2 x 60 W A-15 E-26

2 x 13 W twist lock GU24 self ballasted lamp

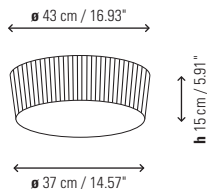

- 0124907CU BRASS-CREAM TRANSLUCENT RIBBON
- 0124905CU INOX-CREAM TRANSLUCENT RIBBON
- 0124907CGU BRASS-CREAM TRANSLUCENT RIBBON / GU24
- 0124905CGU INOX-CREAM TRANSLUCENT RIBBON / GU24

- 0124907BU BRASS-WHITE TRANSLUCENT RIBBON
- 0124905BU INOX-WHITE TRANSLUCENT RIBBON
- 0124907BGU BRASS-WHITE TRANSLUCENT RIBBON / GU24
- 0124905BGU INOX-WHITE TRANSLUCENT RIBBON / GU24

- 0124907 TU BRASS-WHITE COTTON
- 0124905 TU INOX-WHITE COTTON
- 0124907 TGU BRASS-WHITE COTTON / GU24
- 0124905 TGU INOX-WHITE COTTON / GU24

Diffuser opal glass

**PLAFONET - 02**  
**FONDA EUROPA**

CEILING



4 x 60 W A-15 E-26

4 x 13 W twist lock GU24 self ballasted lamp

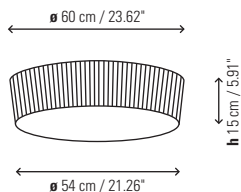

- 0224907CU BRASS-CREAM TRANSLUCENT RIBBON
- 0224905CU INOX-CREAM TRANSLUCENT RIBBON
- 0224907CGU BRASS-CREAM TRANSLUCENT RIBBON / GU24
- 0224905CGU INOX-CREAM TRANSLUCENT RIBBON / GU24

- 0224907BU BRASS-WHITE TRANSLUCENT RIBBON
- 0224905BU INOX-WHITE TRANSLUCENT RIBBON
- 0224907BGU BRASS-WHITE TRANSLUCENT RIBBON / GU24
- 0224905BGU INOX-WHITE TRANSLUCENT RIBBON / GU24

- 0224907 TU BRASS-WHITE COTTON
- 0224905 TU INOX-WHITE COTTON
- 0224907 TGU BRASS-WHITE COTTON / GU24
- 0224905 TGU INOX-WHITE COTTON / GU24

Diffuser opal glass

Photometry **€€** available

**PLAFONET - 03**  
**FONDA EUROPA**

CEILING



6 x 20 W E-26 self ballasted lamp

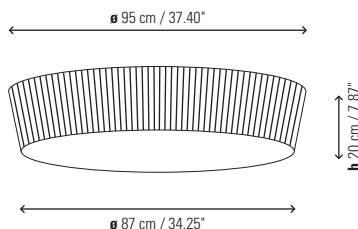

- 0324907 CU BRASS-CREAM TRANSLUCENT RIBBON
- 0324905 CU INOX-CREAM TRANSLUCENT RIBBON

- 0324907 BU BRASS-WHITE TRANSLUCENT RIBBON
- 0324905 BU INOX-WHITE TRANSLUCENT RIBBON

- 0324907 TU BRASS-WHITE COTTON
- 0324905 TU INOX-WHITE COTTON

Polycarbonate opal diffuser

**FINISHING**

BRASS INOX WHITE COTTON CREAM RIBBON WHITE RIBBON

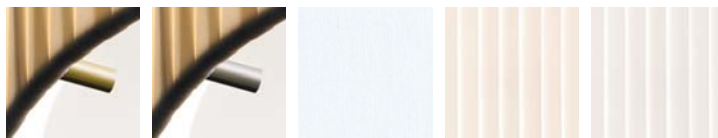







**RONDO - F**  
CEILING

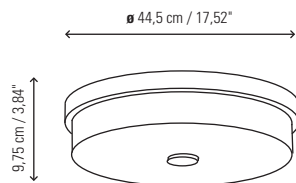

- 5015005FU SATIN NICKEL
- 5015006FU BRILLIANT CHROME
- 5015008FU GREY GRAPHITE

*Inner cotton shade in polyester*

- P-576U WHITE TRANSLUCENT RIBBON
- P-577U CREAM TRANSLUCENT RIBBON
- P-578U WHITE COTTON

*Diffuser: optical matte glass diffuser*

**RONDO - I**  
CEILING

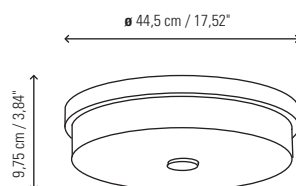

- 5015005IU SATIN NICKEL
- 5015006IU BRILLIANT CHROME
- 5015008IU GREY GRAPHITE

*Inner cotton shade in polyester*

- P-576U WHITE TRANSLUCENT RIBBON
- P-577U CREAM TRANSLUCENT RIBBON
- P-578U WHITE COTTON

*Diffuser: optical matte glass diffuser*



**FINISHING**

BRILLIANT CHROME    SATIN NICKEL    GREY GRAPHITE    WHITE COTTON    CREAM RIBBON    WHITE RIBBON





**SIAM - 01**  
CEILING



3 x 20 W T4 E-26

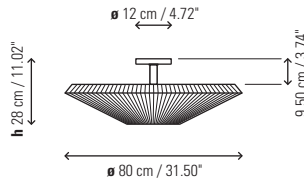

0132005U SATIN NICKEL  
0132001U WHITE 9010

Lampshade:  
P-686CU WHITE TRANSLUCENT RIBBON  
P-687CU CREAM TRANSLUCENT RIBBON  
P-688CU RED TRANSLUCENT RIBBON

**SIAM - 02**  
CEILING



6 x 60 W A-15 E-26

6 x 20 W T4 E-26 self ballasted lamp

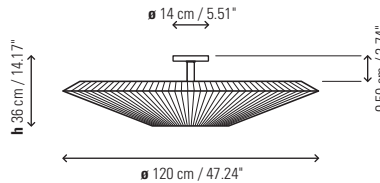

0232005PU STRUCTURE 01 SATIN NICKEL  
0232001PU STRUCTURE 01 WHITE 9010  
0232005GU STRUCTURE 02 SATIN NICKEL  
0232001GU STRUCTURE 02 WHITE 9010

Lampshade:  
P-698CU WHITE TRANSLUCENT RIBBON  
P-699CU CREAM TRANSLUCENT RIBBON  
P-700CU RED TRANSLUCENT RIBBON

**BIG FORMAT**

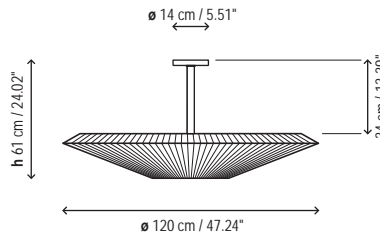

Photometry € available

This ceiling lamp allows several individual or group compositions. Available in two sizes: 185 cm and 430 cm structure. Superimposing shades partially, one on another, we will obtain a mural suitable for each space and need.

**SIAM - 03**  
CEILING



8 x 60 W A-15 E-26

8 x 20 W T4 E-26 self ballasted lamp

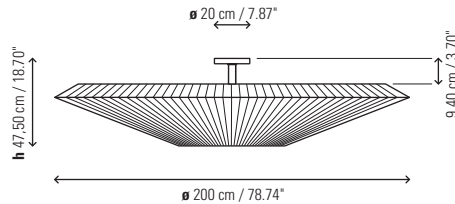

0332005PU STRUCTURE 01 SATIN NICKEL  
0332001PU STRUCTURE 01 WHITE 9010  
0332005GU STRUCTURE 02 SATIN NICKEL  
0332001GU STRUCTURE 02 WHITE 9010

D0332005LPU SATIN NICKEL  
D0332001LPU WHITE 9010  
D0332005LGU SATIN NICKEL  
D0332001LGU WHITE 9010

Lampshade:  
P-690CU WHITE TRANSLUCENT RIBBON  
P-691CU CREAM TRANSLUCENT RIBBON  
P-692CU RED TRANSLUCENT RIBBON

**SIAM - 03**  
OPTIONAL LED



Led: 135 W  
Lumens: 10.100 lm  
Degrees Kelvin: 2.600°

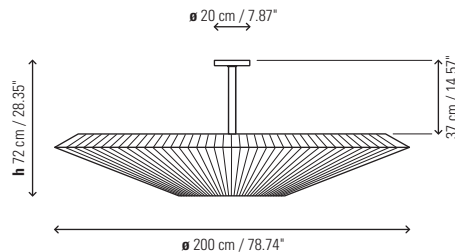

Photometry € available

This ceiling lamp allows several individual or group compositions. Available in two sizes: 185 cm and 430 cm structure. Superimposing shades partially, one on another, we will obtain a mural suitable for each space and need.

**BIG FORMAT**

**FAMILY**

PAG. 154 154 198 198 198

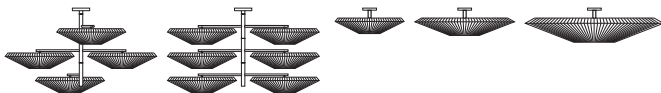

**FINISHING**

BLACK 9010 SATIN NICKEL CREAM RIBBON WHITE RIBBON RED RIBBON











**URBAN - 01**  
CEILING



2 x 60 W A-15 E-26

2 x 14 W T4 E-26 self ballasted lamp

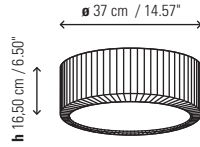

- 0132506BU CHROME-WHITE TRANSLUCENT RIBBON
- 0132506CU CHROME-CREAM TRANSLUCENT RIBBON
- 0132506RU CHROME-RED TRANSLUCENT RIBBON

Photometry **CE** available

**URBAN - 02**  
CEILING



4 x 60 W A-15 E-26

4 x 14 W T4 E-26 self ballasted lamp

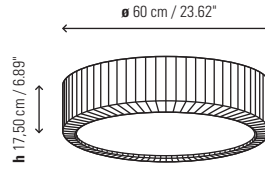

- 0232506BU CHROME-WHITE TRANSLUCENT RIBBON
- 0232506CU CHROME-CREAM TRANSLUCENT RIBBON
- 0232506RU CHROME-RED TRANSLUCENT RIBBON

Photometry **CE** available

**URBAN - 03**  
CEILING



6 x 36 W 2G11

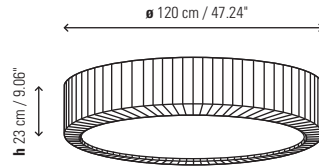

- 0332506BU CHROME-WHITE TRANSLUCENT RIBBON
- 0332506CU CHROME-CREAM TRANSLUCENT RIBBON
- 0332506RU CHROME-RED TRANSLUCENT RIBBON

- D0332506BU DIMMING BALLAST/CHROME-WHITE TRANSLUCENT RIBBON
- D0332506CU DIMMING BALLAST/CHROME-CREAM TRANSLUCENT RIBBON
- D0332506RU DIMMING BALLAST/CHROME-RED TRANSLUCENT RIBBON

Photometry **CE** available

**FAMILY**

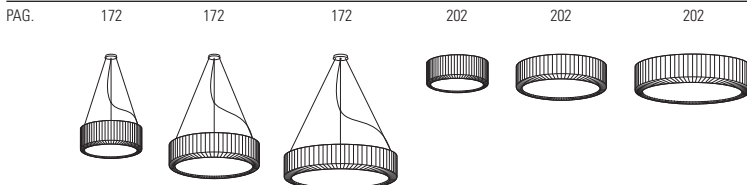

**FINISHING**





**BIG FORMAT**







# *DESK LAMP*

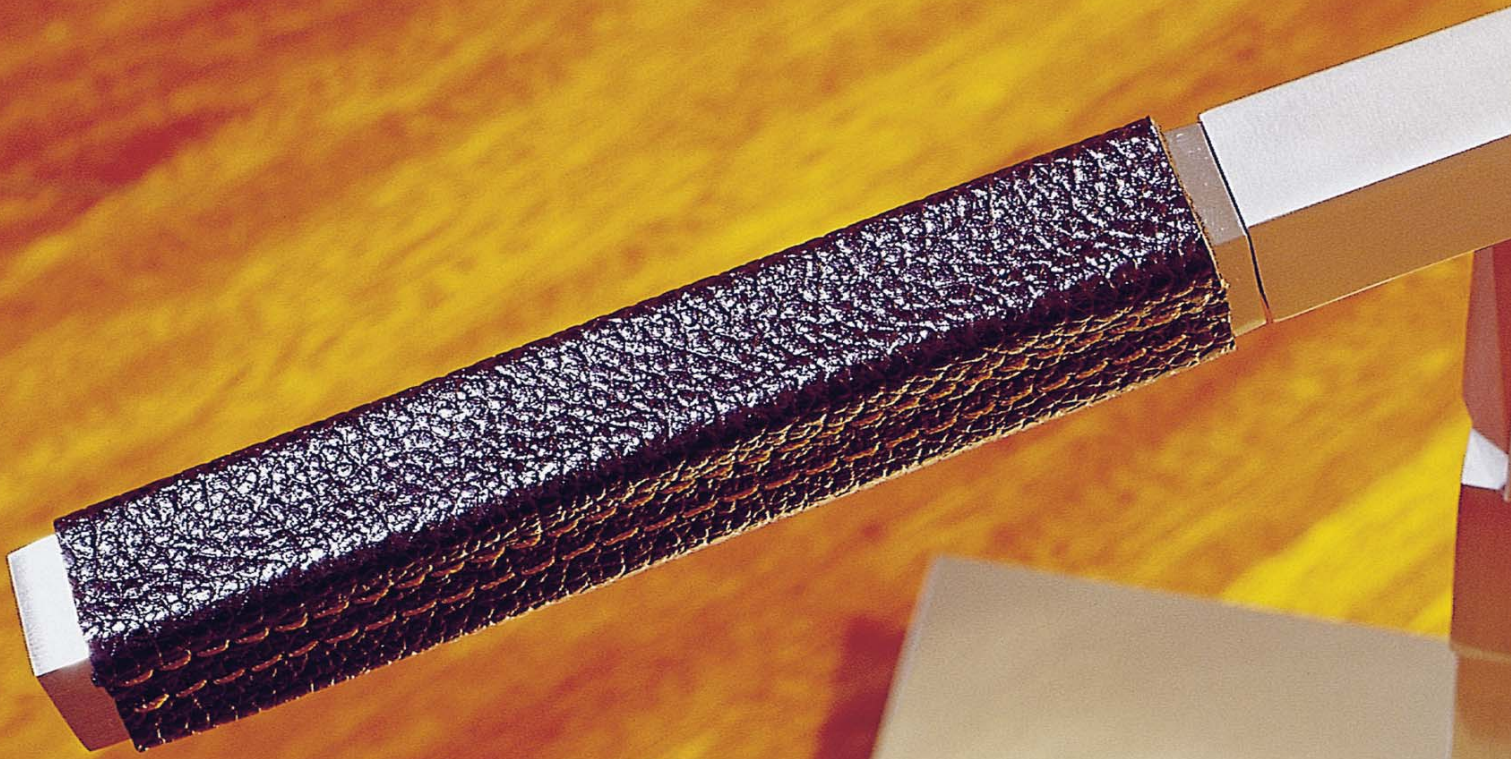



**CARLOTA**

DESK LAMP



1 x 60 W A-15 E-26

1 x 13 W twist lock GU24 self ballasted lamp

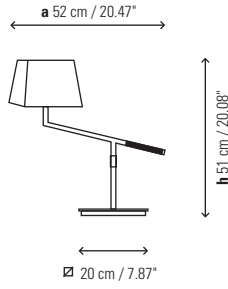

- 1924005U SATIN NICKEL
- 1924006U BRILLIANT CHROME
- 1924060U NICKEL DARK LEATHER
- 1924061U NICKEL CARAMEL LEATHER
  
- 1924005GU SATIN NICKEL / GU24
- 1924006GU BRILLIANT CHROME / GU24
- 1924060GU NICKEL DARK LEATHER / GU24
- 1924061GU NICKEL CARAMEL LEATHER / GU24

Square lampshade 7.87" x 5.91" x 3.94"

- P-107U COTTON
- P-202U WHITE TRANSLUCENT RIBBON
- P-203U CREAM TRANSLUCENT RIBBON

Swivel arm

**FINISHING**

COTTON CREAM RIBBON WHITE RIBBON



BRILLIANT CHROME SATIN NICKEL DARK LEATHER CARAMEL LEATHER

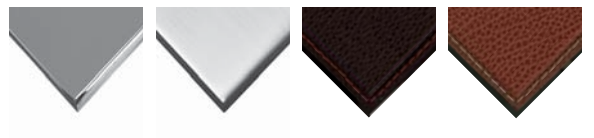

**FAMILY**

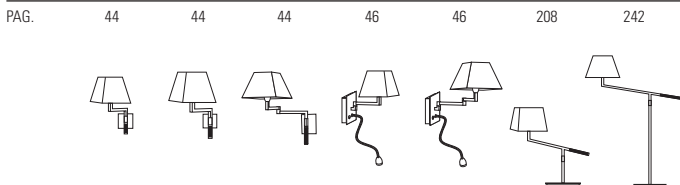



**CLUB - T**  
TABLE



1 x 60 W A-15 E-26

1 x 13 W T2 E-26 self ballasted lamp

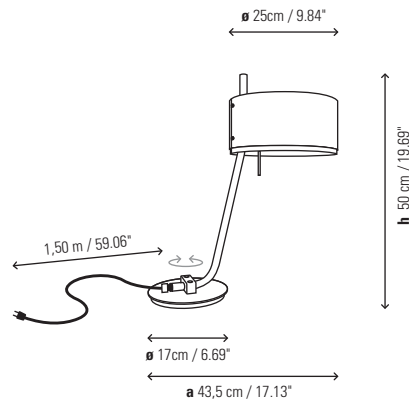

1932812U MATTE BLACK-NICKEL

LAMPSHADE  
Black aluminum shade  
White PVC interior B1 Flame Resistant  
Included aluminum top diffuser

Swivel base  
Lampholder swicht  
Transparent wire



**FAMILY**

PAG. 48 48 94 210 244



**FINISHING**

SATIN NICKEL MATTE BLACK

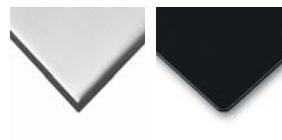



### DANONA - MINI

BEDSIDE



1 x 60 W A-15 E-26

1 x 13 W twist lock GU24 self ballasted lamp

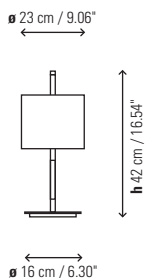

- 2023105U SATIN NICKEL
- 2023160U NICKEL DARK LEATHER
- 2023161U NICKEL CARAMEL LEATHER

- 2023105GU SATIN NICKEL / GU24
- 2023160GU NICKEL DARK LEATHER / GU24
- 2023161GU NICKEL CARAMEL LEATHER / GU24

Lampshade 9.06" x 6.69" x 9.06"  
Lampshade components and polycarbonate diffuser included

- P-230U COTTON
- P-003U CREAM TRANSLUCENT RIBBON
- P-004U WHITE TRANSLUCENT RIBBON

### DANONA - MESA

TABLE



1 x 60 W A-15 E-26

1 x 13 W twist lock GU24 self ballasted lamp

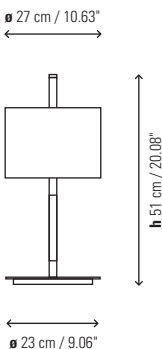

- 2123105U SATIN NICKEL
- 2123160U NICKEL DARK LEATHER
- 2123161U NICKEL CARAMEL LEATHER

- 2123105GU SATIN NICKEL / GU24
- 2123160GU NICKEL DARK LEATHER / GU24
- 2123161GU NICKEL CARAMEL LEATHER / GU24

Lampshade 10.63" x 7.09" x 10.63"  
Lampshade components and polycarbonate diffuser included

- P-227U COTTON
- P-005U CREAM TRANSLUCENT RIBBON
- P-006U WHITE TRANSLUCENT RIBBON

#### FAMILY

PAG. 96 96 212 212 246

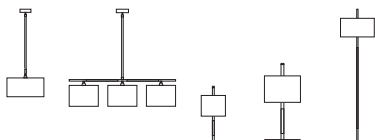

#### FINISHING

SATIN NICKEL DARK LEATHER CARAMEL LEATHER COTTON CREAM RIBBON WHITE RIBBON

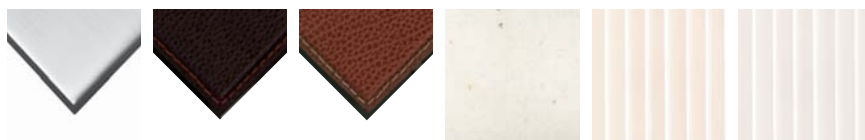



**EMA**

TABLE



1 x 60 W A-15 E-26

1 x 13 W twist lock GU24 self ballasted lamp

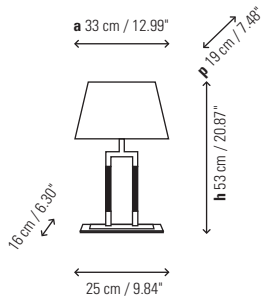

- 2119405U SATIN NICKEL
- 2119460U NICKEL DARK LEATHER
- 2119461U NICKEL CARAMEL LEATHER

- 2119405GU SATIN NICKEL / GU24
- 2119460GU NICKEL DARK LEATHER / GU24
- 2119461GU NICKEL CARAMEL LEATHER / GU24

INOX BASE

Finish: Satin nickel – Brilliant chrome

Rectangular lampshade 12.99" x 7.48" x 8.27"

- P-478U LINEN
- P-479U COTTON

**FAMILY**

PAG. 214 248



**FINISHING**

BRILLIANT CHROME SATIN NICKEL DARK LEATHER CARAMEL LEATHER COTTON LINEN

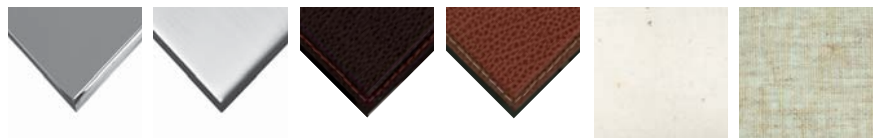





**INARI**

TABLE

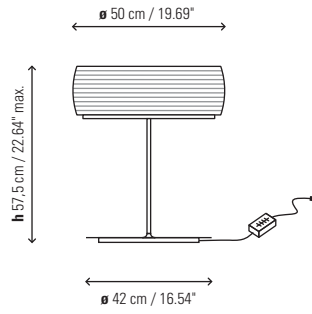
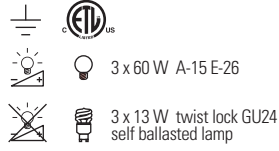

2220205U NICKEL-OPAL GLASS  
2220206U CHROME-OPAL GLASS

2220205GU NICKEL-OPAL GLASS / GU24  
2220206GU CHROME-OPAL GLASS / GU24

Lamp with incorporated dimmer  
Consult dimming options

*Due to the nature of the hand blown cristal, natural variations should be expected and will not be considered an imperfection.*

**FAMILY**

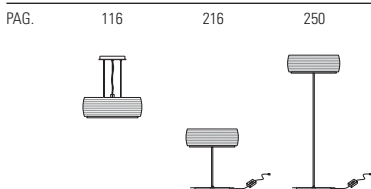

**FINISHING**

BRILLIANT CHROME SATIN NICKEL OPAL GLASS

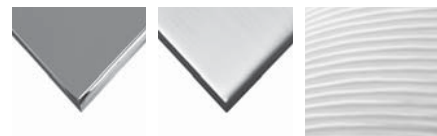



**MANI - MINI**  
BEDSIDE



1 x 60 W A-15 E-26

1 x 13 W twist lock GU24 self ballasted lamp

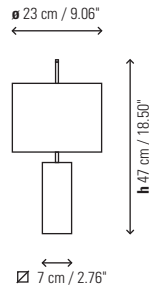

- 2028512U NICKEL NATURAL WOOD
- 2028513U NICKEL CHERRY WOOD
- 2028514U NICKEL WALNUT WOOD

- 2028512GU NICKEL NATURAL WOOD / GU24
- 2028513GU NICKEL CHERRY WOOD / GU24
- 2028514GU NICKEL WALNUT WOOD / GU24

Lampshade 9.06" x 6.69" x 9.06"  
Lampshade components and polycarbonate diffuser included

- P-003U CREAM TRANSLUCENT RIBBON
- P-004U WHITE TRANSLUCENT RIBBON
- P-230U COTTON

**MANI - MESA**  
TABLE



2 x 60 W A-15 E-26

2 x 13 W twist lock GU24 self ballasted lamp

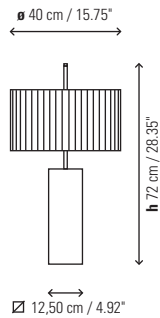

- 2128512U NICKEL NATURAL WOOD
- 2128513U NICKEL CHERRY WOOD
- 2128514U NICKEL WALNUT WOOD

- 2128512GU NICKEL NATURAL WOOD / GU24
- 2128513GU NICKEL CHERRY WOOD / GU24
- 2128514GU NICKEL WALNUT WOOD / GU24

Lampshade 15.75" x 8.66" x 15.75"  
Lampshade components and polycarbonate diffuser included

- P-133U COTTON
- P-137U WHITE TRANSLUCENT RIBBON
- P-138U CREAM TRANSLUCENT RIBBON



**FINISHING**

SATIN NICKEL    WHITE RIBBON    CREAM RIBBON    COTTON    NATURAL WOOD    CHERRY WOOD    WALNUT WOOD





**MEI OVAL - T**

TABLE



1 x 60 W A-15 E-26

1 x 13 W twist lock GU24 self ballasted lamp

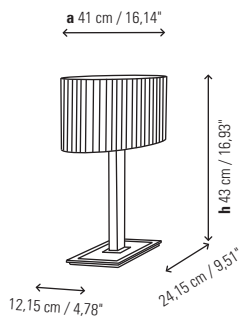

2125023U CHROME BLACK GLASS  
2125017U NICKEL BLACK GLASS

2125023GU CHROME BLACK GLASS / GU24  
2125017GU NICKEL BLACK GLASS / GU24

Oval lampshade 16.14" x 6.89" x 5.91"

P-551DU WHITE TRANSLUCENT RIBBON  
P-552DU CREAM TRANSLUCENT RIBBON  
P-553DU BLACK TRANSLUCENT RIBBON  
P-554DU WHITE COTTON

Upper diffuser black glass

**MEI OVAL - T/USB**

TABLE



1 x 60 W A-15 E-26

1 x 13 W twist lock GU24 self ballasted lamp

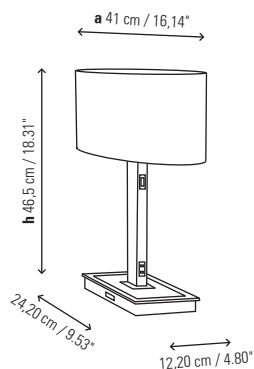

2125017USBU NICKEL BLACK GLASS  
2125023USBU CHROME BLACK GLASS

2125017USBGU NICKEL BLACK GLASS  
2125023USBGU CHROME BLACK GLASS

Oval lampshade 16.14" x 6.30" x 5.91"

P-551DU WHITE TRANSLUCENT RIBBON  
P-552DU CREAM TRANSLUCENT RIBBON  
P-553DU BLACK TRANSLUCENT RIBBON  
P-554DU WHITE COTTON

Upper diffuser black glass

On/off switch located on the stem  
Switch located on the stem  
USB port located on the base



**FAMILY**

PAG. 66 142 220 254

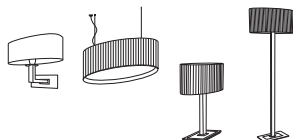

**FINISHING**

BRILLIANT CHROME SATIN NICKEL BLACK GLASS WHITE RIBBON CREAM RIBBON BLACK RIBBON COTTON





**MUF - 01**

TABLE



- 1 x 100 W A-19 E-26
- +
- 1 x 40 W A-15 E-12

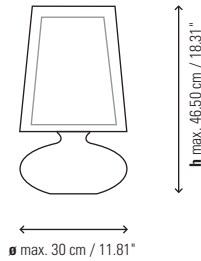

2215521U *BLOWN OPAL GLASS-CHROME*

*Outer lampshade: 10.63" x 10.63" x 7.87"*

P-561U *WHITE TRANSLUCENT RIBBON*

P-564EU *BLACK MESH*

P-565EU *RED MESH*

*Inner lampshade: 7.87" x 10.24" x 5.51"*

P-564 IU *BLACK MESH*

P-565 IU *RED MESH*

*With 3 lighting/mood switch on/off positions*

*Inner shade made of a fire-resistant polyester rigid film*

**MUF - 02**

TABLE



- 1 x 100 W A-19 E-26
- +
- 2 x 40 W A-15 E-12

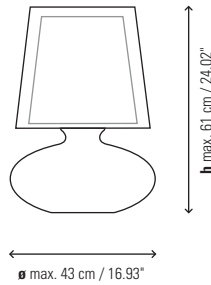

2215522U *BLOWN OPAL GLASS-CHROME*

*Outer lampshade: 15.75" x 14.17" x 12.20"*

P-580U *WHITE TRANSLUCENT RIBBON*

P-570EU *BLACK MESH*

P-571EU *RED MESH*

*Inner lampshade: 11.81" x 11.81" x 9.06"*

P-570 IU *BLACK MESH*

P-571 IU *RED MESH*

*With 3 lighting/mood switch on/off positions*

*Inner shade made of a fire-resistant polyester rigid film*



*Due to the nature of the hand blown cristal, natural variations should be expected and will not be considered an imperfection.*

**ACABADOS / FINISHING**

WHITE RIBBON

BLACK MESH

RED MESH

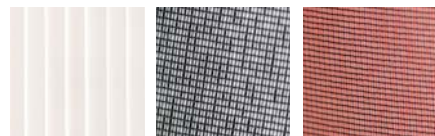









**ONNE**

TABLE



1 x 100 W A-19 E-26

1 x 18 W GU24 self ballasted lamp

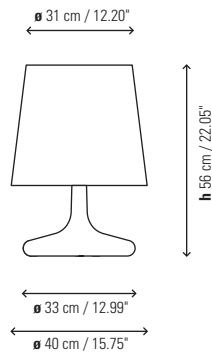

- 2210621U WHITE BRILLIANT LACQUER
- 2210617U BLACK BRILLIANT LACQUER
- 2210622U RED BRILLIANT LACQUER
  
- 2210621GU WHITE BRILLIANT LACQUER / GU24
- 2210617GU BLACK BRILLIANT LACQUER / GU24
- 2210622GU RED BRILLIANT LACQUER / GU24

*Diffuser included: silver-mirror methacrylate with white shade and black-mirror methacrylate with black shade*

- P-660U WHITE RIBBON
- P-658U BLACK FABRIC - ORANGE INSIDE
- P-659U WHITE FABRIC - ORANGE INSIDE
- P-761U RED RIBBON

*Material: Polyurethane  
Finishing: Brilliant lacquer*



**FINISHING**

- WHITE RIBBON
- COTTON WHITE
- BLACK COTTON
- RED RIBBON









**SPOCK - MINI**

TABLE



4 x 1.2 W LED  
 Led: 4.8 W Osram  
 Lumens: 408 lm  
 Degrees Kelvin: 3.000°  
 CRI: 85 (typ)

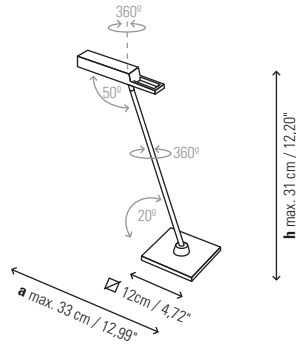

- 2010511LU LED CHROME-WHITE
- 2010512LU LED CHROME
- 2010510LU LED CHROME-GRAPHITE

Zamac injected orientable hood  
 Stainless steel base

**DIFFUSER:**  
 Circular rotation 360°  
 Vertical rotation 50°

**MAST:**  
 Circular rotation 360°  
 Mast inclination 20°

**SPOCK - T**

TABLE



4 x 1.2 W LED  
 Led: 4.8 W Osram  
 Lumens: 408 lm  
 Degrees Kelvin: 3.000°  
 CRI: 85 (typ)

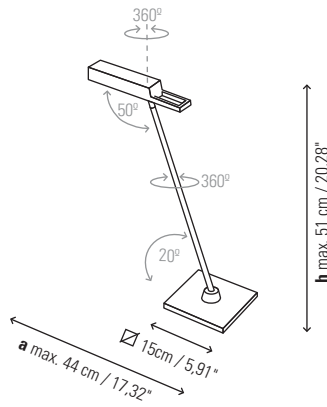

- 1910511LU LED CHROME-WHITE
- 1910512LU LED CHROME
- 1910510LU LED CHROME-GRAPHITE

Zamac injected orientable hood  
 Stainless steel base

**DIFFUSER:**  
 Circular rotation 360°  
 Vertical rotation 50°

**MAST:**  
 Circular rotation 360°  
 Mast inclination 20°



**FAMILY**

PAG. 80 230 230 256

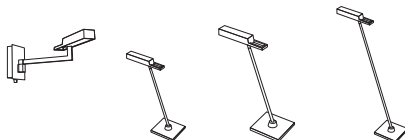

**FINISHING**

BRILLIANT CHROME WHITE GRAPHITE











**TAU - MINI**  
BEDSIDE



1 x 60 W A-15 E-26

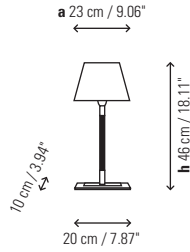

- 2023960U NICKEL DARK LEATHER
- 2023961U NICKEL CARAMEL LEATHER
- 2023905U SATIN NICKEL-CHROME

INOX BASE  
Finish: Satin nickel-Brilliant chrome

Rectangular lampshade 9.06" x 5.12" x 5.91"

- P-474U LINEN
- P-475U COTTON
- P-671U WHITE TRANSLUCENT RIBBON
- P-672U CREAM TRANSLUCENT RIBBON

**TAU - MESA**  
TABLE



1 x 60 W A-15 E-26

1 x 13 W twist lock GU24 self ballasted lamp

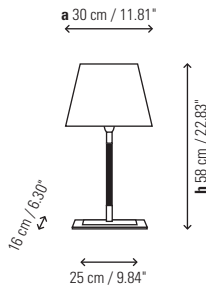

- 2223960U NICKEL DARK LEATHER
- 2223961U NICKEL CARAMEL LEATHER
- 2223905U SATIN NICKEL-CHROME

- 2223960GU NICKEL DARK LEATHER / GU24
- 2223961GU NICKEL CARAMEL LEATHER / GU24
- 2223905GU SATIN NICKEL-CHROME / GU24

INOX BASE  
Finish: Satin nickel-Brilliant chrome

Rectangular lampshade 12.99" x 8.66" x 8.27"

- P-478U LINEN
- P-479U COTTON
- P-674U WHITE TRANSLUCENT RIBBON
- P-675U CREAM TRANSLUCENT RIBBON

**FAMILY**

PAG. 162 234 234 258



**FINISHING**

BRILLIANT CHROME SATIN NICKEL DARK LEATHER CARAMEL LEATHER COTTON CREAM RIBBON WHITE RIBBON LINEN

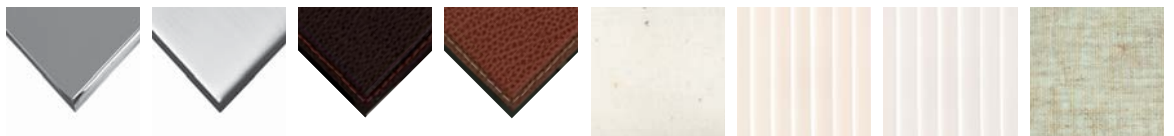



**TAU - MADERA**  
TABLE



1 x 60 W A-15 E-26

1 x 13 W twist lock GU24 self ballasted lamp

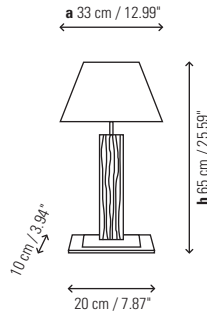

- 2123931U NICKEL CHERRY
- 2123932U NICKEL WENGUE
- 2123934U NICKEL CEBRANO
- 2123901U NICKEL WHITE LACQUER
  
- 2123931GU NICKEL CHERRY / GU24
- 2123932GU NICKEL WENGUE / GU24
- 2123934GU NICKEL CEBRANO / GU24
- 2123901GU NICKEL WHITE LACQUER / GU24

INOX BASE  
Finish: Satin nickel–Brilliant chrome

Rectangular lampshade 12.99" x 8.66" x 8.27"

- P-478U LINEN
- P-479U COTTON
- P-541U WHITE COTTON
- P-674U WHITE TRANSLUCENT RIBBON
- P-675U CREAM TRANSLUCENT RIBBON

*Cebrano wood may undergo characteristic variations that are not considered to be imperfections in its grain or colour. Each piece is unique because of its properties.*



**FAMILY**

PAG. 236 260

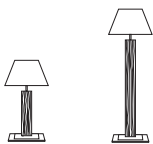

**FINISHING**

BRILLIANT CHROME SATIN NICKEL WENGUE CEBRANO WHITE LACQUER CHERRY LINEN COTTON COTTON WHITE CREAM RIBBON WHITE RIBBON

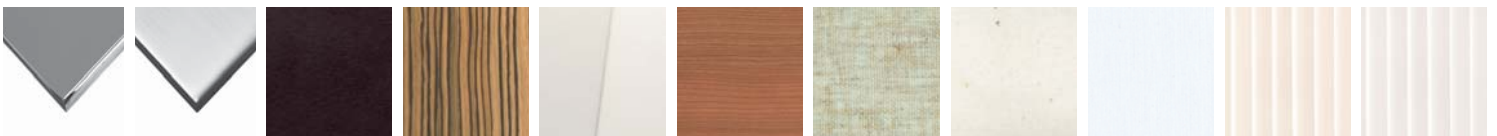



**ULMA - MESA**

TABLE



1 x 100 W A-19 E-26



1 x 18 W twist lock GU24 self ballasted lamp

a 35 cm / 13.78"



h 64 cm / 25.20"

18 cm / 7.09"

2122860U NICKEL DARK LEATHER  
2122861U NICKEL CARAMEL LEATHER

2122860GU NICKEL DARK LEATHER / GU24  
2122861GU NICKEL CARAMEL LEATHER / GU24

Square lampshade 13.78" x 9.45" x 7.09"

P-195U COTTON  
P-117U WHITE TRANSLUCENT RIBBON  
P-118U CREAM TRANSLUCENT RIBBON



**FAMILY**

PAG. 238 262



**FINISHING**

SATIN NICKEL DARK LEATHER CARAMEL LEATHER COTTON CREAM RIBBON WHITE RIBBON

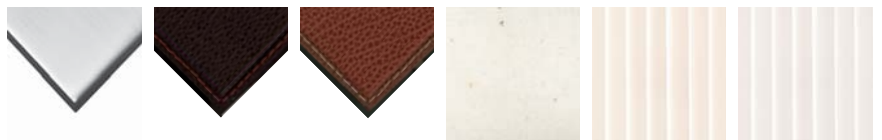







# *FLOOR LAMP*

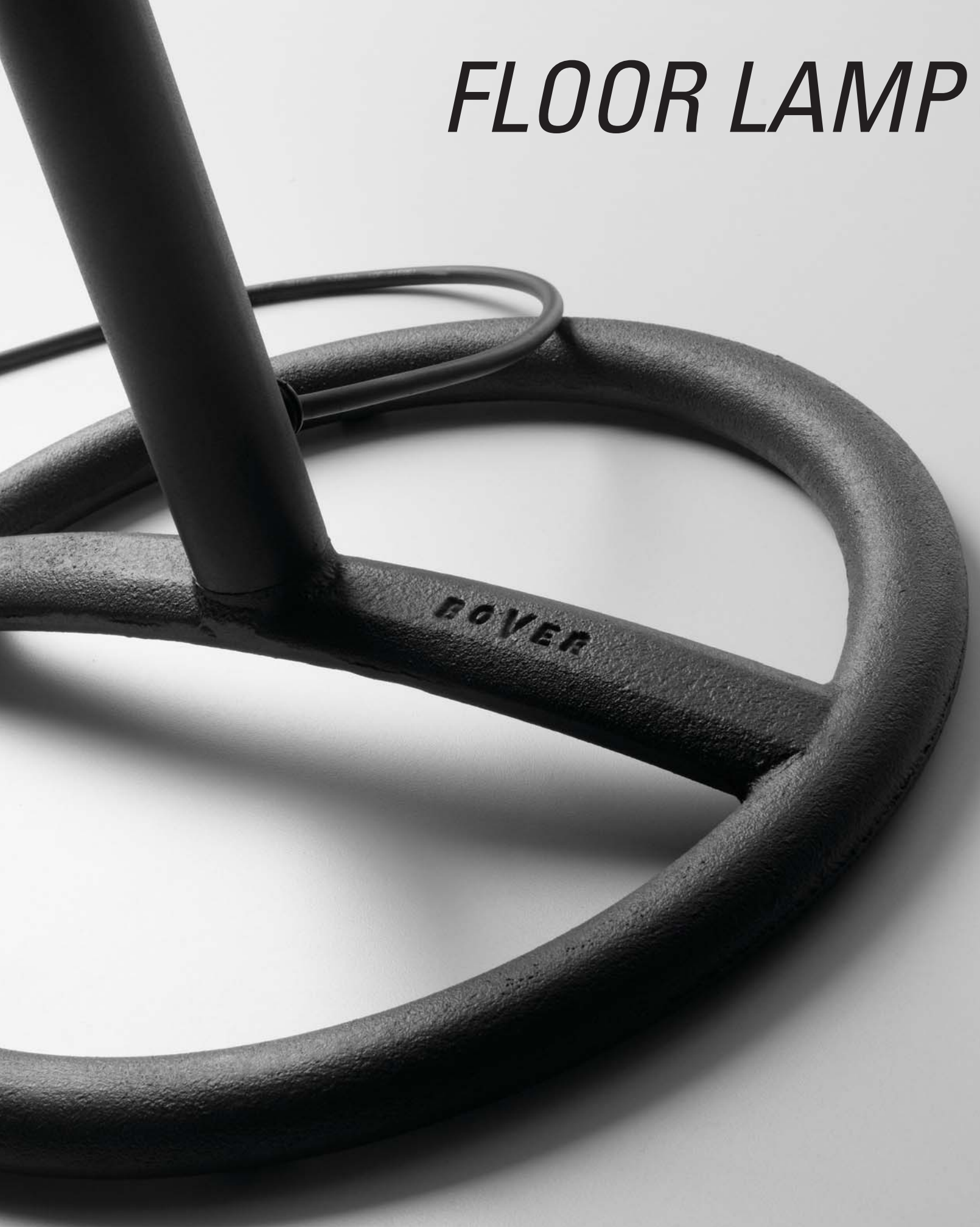

**CARLOTA - PIE**  
FLOOR



1 x 60 W A-19 E-26

1 x 13 W twist lock GU24 self ballasted lamp



- 3124005U SATIN NICKEL
- 3124006U BRILLIANT CHROME
- 3124060U NICKEL DARK LEATHER
- 3124061U NICKEL CARAMEL LEATHER
  
- 3124005GU SATIN NICKEL / GU24
- 3124006GU BRILLIANT CHROME / GU24
- 3124060GU NICKEL DARK LEATHER / GU24
- 3124061GU NICKEL CARAMEL LEATHER / GU24

Square lampshade 10.63" x 8.27" x 5.91"

- P-453U COTTON
- P-455U WHITE TRANSLUCENT RIBBON
- P-456U CREAM TRANSLUCENT RIBBON

Swivel arm

**FINISHING**

COTTON CREAM RIBBON WHITE RIBBON



**FAMILY**

PAG. 44 44 44 46 46 208 242

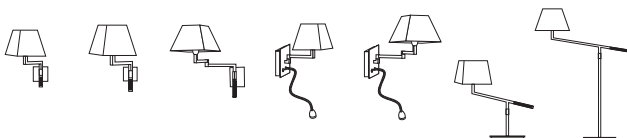

BRILLIANT CHROME SATIN NICKEL DARK LEATHER CARAMEL LEATHER

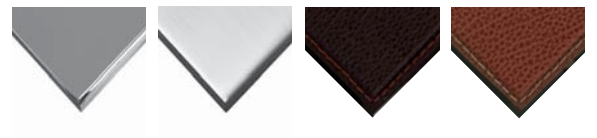



**CLUB - P**  
FLOOR



1 x 60 W A-19 E-26

1 x 15 W T3 E-26 self ballasted lamp

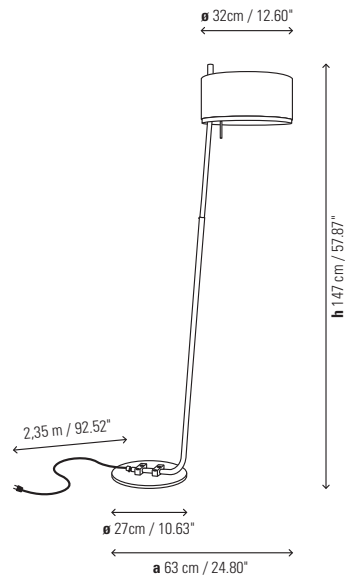

3132812U MATTE BLACK-NICKEL

Black aluminum shade  
White PVC interior B1 Flame Resistant  
Included aluminum top diffuser

Lampholder swicht



**FAMILY**

PAG. 48 48 94 210 244

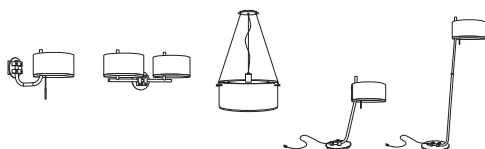

**FINISHING**

SATIN NICKEL MATTE BLACK

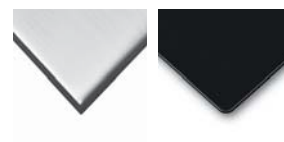



**DANONA - PIE**  
FLOOR



2 x 60 W A-15 E-26

2 x 13 W twist lock GU24 self ballasted lamp

∅ 40 cm / 15.75"



h 165 cm / 64.96"



∅ 30 cm / 11.81"

- 3023105U SATIN NICKEL
- 3023160U NICKEL DARK LEATHER
- 3023161U NICKEL CARAMEL LEATHER

- 3023105GU SATIN NICKEL / GU24
- 3023160GU NICKEL DARK LEATHER / GU24
- 3023161GU NICKEL CARAMEL LEATHER / GU24

Lampshade 15.75" x 8.66" x 15.75"  
Lampshade components and methacrylate diffuser included

- P-133U COTTON
- P-137U WHITE TRANSLUCENT RIBBON
- P-138U CREAM TRANSLUCENT RIBBON

**FAMILY**

PAG. 212 212 230 230 246

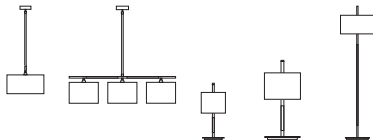

**FINISHING**

SATIN NICKEL DARK LEATHER CARAMEL LEATHER COTTON CREAM RIBBON WHITE RIBBON

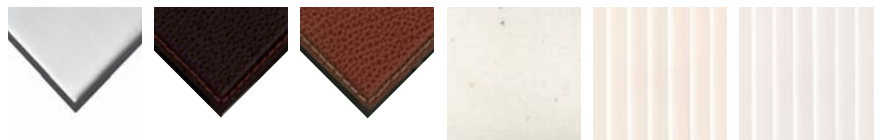





**EMA - PIE**  
FLOOR



1 x 100 W A-19 E-26

1 x 18 W twist lock GU24 self ballasted lamp

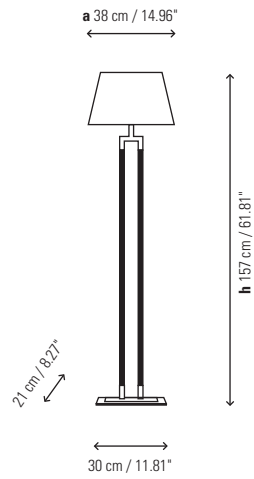

- 3019405U SATIN NICKEL
- 3019460U NICKEL DARK LEATHER
- 3019461U NICKEL CARAMEL LEATHER
  
- 3019405GU SATIN NICKEL / GU24
- 3019460GU NICKEL DARK LEATHER / GU24
- 3019461GU NICKEL CARAMEL LEATHER / GU24

**Material:** INOX BASE  
**Finish:** Satin nickel – Brilliant chrome

Rectangular lampshade 14.96" x 8.66" x 9.84"

- P-480U LINEN
- P-481U COTTON

**FAMILY**

PAG. 214 248



**FINISHING**

BRILLIANT CHROME SATIN NICKEL DARK LEATHER CARAMEL LEATHER COTTON LINEN

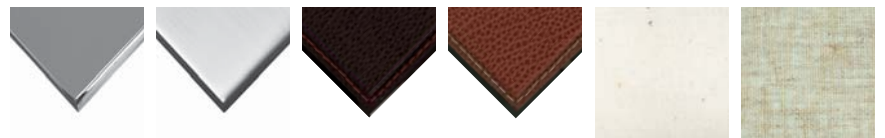



**INARI - PIE**  
FLOOR



3 x 100 W A-19 E-26

3 x 18 W twist lock GU24 self ballasted lamp

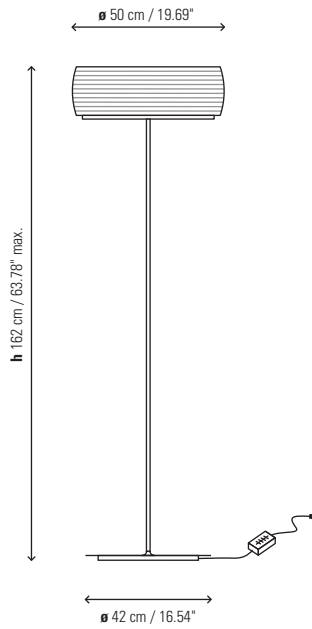

3020205U NICKEL-OPAL GLASS  
3020206U CHROME-OPAL GLASS

3020205GU NICKEL-OPAL GLASS / GU24  
3020206GU CHROME-OPAL GLASS / GU24

Lamp with incorporated dimmer  
Adjustable light intensity by using dimming bulbs.

*Due to the nature of the hand blown cristal, natural variations should be expected and will not be considered an imperfection.*

**FAMILY**

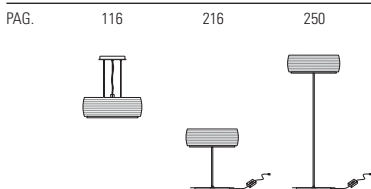

**FINISHING**

BRILLIANT CHROME SATIN NICKEL OPAL GLASS

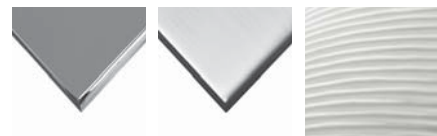



**MAXI - 01**

FLOOR



4 x 60 W A-15 E-26

4 x 13 W twist lock GU24 self ballasted lamp

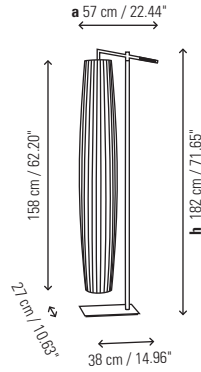

- 3019505U SATIN NICKEL
- 3019560U NICKEL DARK LEATHER
- 3019561U NICKEL CARAMEL LEATHER

- 3019505GU SATIN NICKEL / GU24
- 3019560GU NICKEL DARK LEATHER / GU24
- 3019561GU NICKEL CARAMEL LEATHER / GU24

Lampshade 62.20" x 9.84"

- P-507TU TOP CREAM RIBBON
- P-508TU TOP WHITE RIBBON

**MAXI - 02**

FLOOR



4 x 60 W A-15 E-26

4 x 13 W twist lock GU24 self ballasted lamp

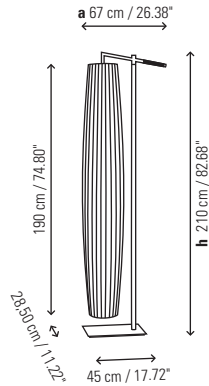

- 3219505U SATIN NICKEL
- 3219560U NICKEL DARK LEATHER
- 3219561U NICKEL CARAMEL LEATHER

- 3219505GU SATIN NICKEL / GU24
- 3219560GU NICKEL DARK LEATHER / GU24
- 3219561GU NICKEL CARAMEL LEATHER / GU24

Lampshade 74.80" x 11.81"

- P-506TU TOP CREAM RIBBON
- P-509TU TOP WHITE RIBBON



**FAMILY**

PAG. 32 32 32 128 128 128 252 252

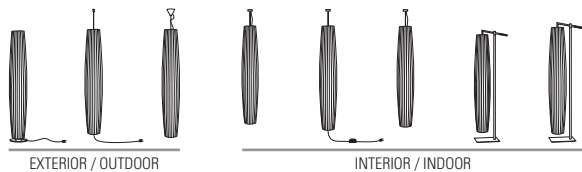

**FINISHING**

SATIN NICKEL DARK LEATHER CARAMEL LEATHER CREAM RIBBON WHITE RIBBON

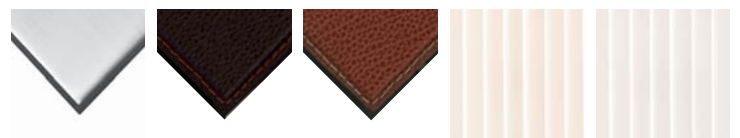



**MEI OVAL - P**  
FLOOR



1 x 100 W A-19 E-26

1 x 20 W T4 E-26 self ballasted lamp

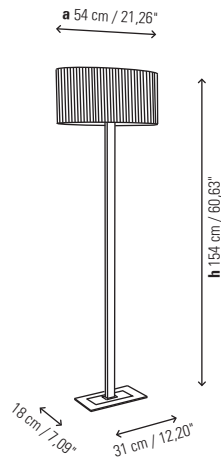

3025023U CHROME BLACK GLASS  
3025017U NICKEL BLACK GLASS

Oval lampshade 21.26" x 9.45" x 9.06"

P-557U WHITE TRANSLUCENT RIBBON  
P-558U CREAM TRANSLUCENT RIBBON  
P-559U BLACK TRANSLUCENT RIBBON  
P-560U WHITE COTTON

**FAMILY**

PAG. 66 142 220 254

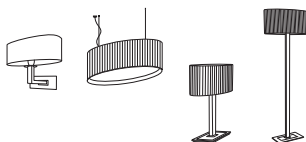

**FINISHING**

BRILLIANT CHROME SATIN NICKEL BLACK GLASS WHITE RIBBON CREAM RIBBON BLACK RIBBON COTTON







**SPOCK - P**  
FLOOR



4 x 1.2 W LED  
Lcd: 4.8 W Osram  
Lumens: 408 lm  
Degrees Kelvin: 3.000°  
CRI: 85 (typ)

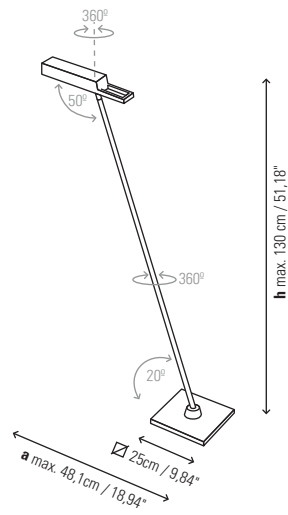

- 3110511LU LED CHROME-WHITE
- 3110512LU LED CHROME
- 3110510LU LED CHROME-GRAPHITE

Zamac injected orientable hood  
Stainless steel base

**DIFFUSER:**  
Circular rotation 360°  
Vertical rotation 50°

**MAST:**  
Circular rotation 360°  
Mast inclination 20°

Photometry available



**FAMILY**

PAG. 80 230 230 256

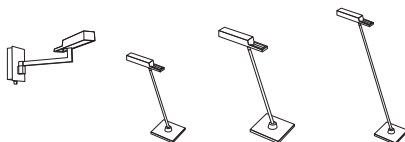

**FINISHING**

BRILLIANT CHROME WHITE GRAPHITE





**TAU - PIE**

FLOOR



1 x 60 W A-15 E-26

1 x 13 W twist lock GU24 self ballasted lamp

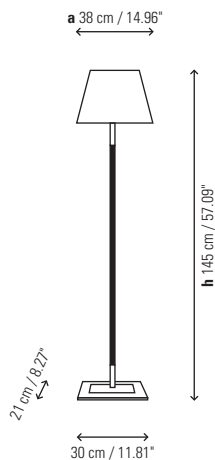

- 3023960U NICKEL DARK LEATHER
- 3023961U NICKEL CARAMEL LEATHER
- 3023905U SATIN NICKEL-CHROME

- 3023960GU NICKEL DARK LEATHER / GU24
- 3023961GU NICKEL CARAMEL LEATHER / GU24
- 3023905GU SATIN NICKEL-CHROME / GU24

INOX BASE  
Finish: Satin nickel-Brilliant chrome

Rectangular lampshade 14.96" x 9.84" x 10.24"

- P-480U LINEN
- P-481U COTTON
- P-677U WHITE TRANSLUCENT RIBBON
- P-678U CREAM TRANSLUCENT RIBBON

**FAMILY**

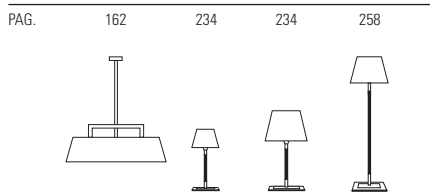

**FINISHING**

BRILLIANT CHROME    SATIN NICKEL    DARK LEATHER    CARAMEL LEATHER    COTTON    CREAM RIBBON    WHITE RIBBON    LINEN

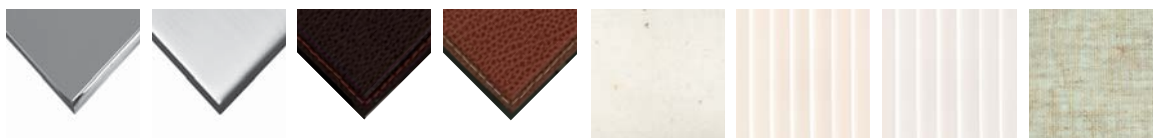



**TAU - PIE MADERA**  
FLOOR



1 x 60 W A-15 E-26

1 x 14 W T4 E-26 self ballasted lamp

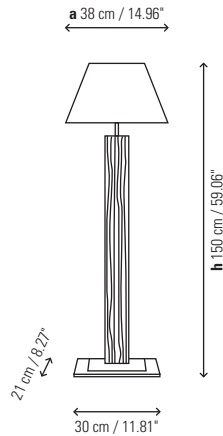

- 3023931U NICKEL CHERRY
- 3023932U NICKEL WENGUE
- 3023934U NICKEL CEBRANO
- 3023901U NICKEL WHITE LACQUER

INOX BASE  
Finish: Satin nickel-Brilliant chrome

Rectangular lampshade 14.96" x 9.84" x 10.24"

- P-480U LINEN
- P-481U COTTON
- P-542U WHITE COTTON
- P-677U WHITE TRANSLUCENT RIBBON
- P-678U CREAM TRANSLUCENT RIBBON



*Cebrano wood may undergo characteristic variations that are not considered to be imperfections in its grain or colour. Each piece is unique because of its properties.*

**FAMILY**

PAG. 236 260

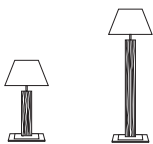

**FINISHING**

BRILLIANT CHROME SATIN NICKEL WENGUE CEBRANO CHERRY CREAM RIBBON WHITE RIBBON LINEN COTTON COTTON WHITE

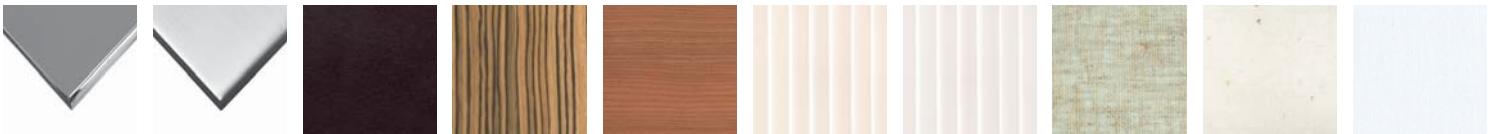



**ULMA - PIE**  
FLOOR



1 x 100 W A-19 E-26

1 x 18 W twist lock GU24 self ballasted lamp

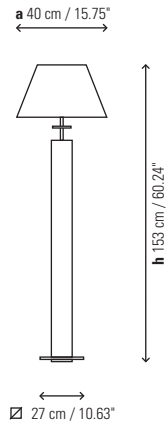

3022860U *NICKEL DARK LEATHER*  
3022861U *NICKEL CARAMEL LEATHER*

3022860GU *NICKEL DARK LEATHER / GU24*  
3022861GU *NICKEL CARAMEL LEATHER / GU24*

*Square lampshade 15.75" x 11.02" x 7.87"*

P-110U *COTTON*  
P-115U *CREAM TRANSLUCENT RIBBON*  
P-116U *WHITE TRANSLUCENT RIBBON*

**FAMILY**

PAG. 238 262

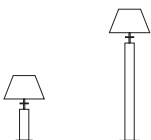

**FINISHING**

SATIN NICKEL    DARK LEATHER    CARAMEL LEATHER    COTTON    CREAM RIBBON    WHITE RIBBON

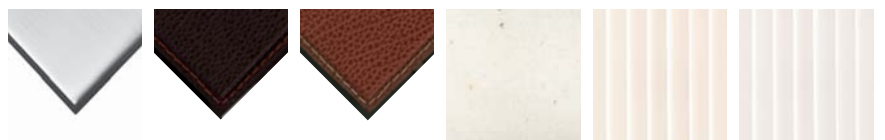







# *HAND-CRAFTING*



**AVANI - MINI**  
WALL LAMP



2 x 60 W A-15 E-26

2 x 13 W twist lock GU24 self ballasted lamp

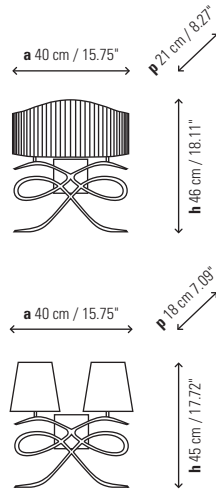

1222003U GRAPHITE BROWN IRON  
1222004U BLACK IRON

1222003GU GRAPHITE BROWN IRON / GU24  
1222004GU BLACK IRON / GU24

Lampshade 14,96" x 7,87"

P-350U PARCHMENT  
P-352U COTTON  
P-354U PLEATED

Lampshade 7.09" x 5.91" x 4.72" Unitary price

P-100U PARCHMENT  
P-103U COTTON

Photometry €€ available

**AVANI - GRANDE**  
WALL LAMP



2 x 60 W A-15 E-26

2 x 13 W twist lock GU24 self ballasted lamp

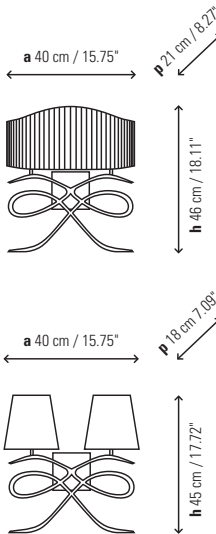

1222103U GRAPHITE BROWN IRON  
1222104U BLACK IRON

1222103GU GRAPHITE BROWN IRON  
1222104GU BLACK IRON

Lampshade CAPELLA 17.52" x 9.06"

P-360U PARCHMENT  
P-362U COTTON  
P-364U PLEATED

Lampshade 7.09" x 7.09" x 4.72" Unitary price

P-370U PARCHMENT  
P-373U COTTON

Photometry €€ available



**FINISHING**

BROWN IRON    BLACK IRON    PARCHMENT    COTTON    GREY GRAPHITE

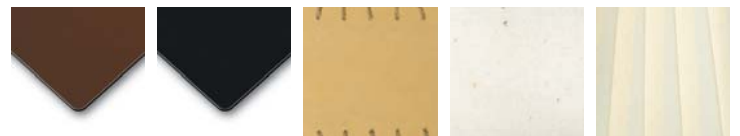



**FERRARA - 1 LUZ**

WALL LAMP



1 x 60 W A-15 E-26

1 x 13 W twist lock GU24 self ballasted lamp

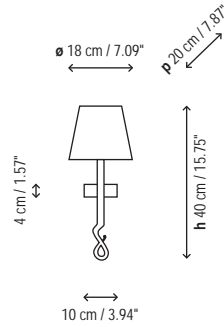

- 1124204U BLACK IRON
- 1124203U GRAPHITE BROWN IRON

- 1124204GU BLACK IRON / GU24
- 1124203GU GRAPHITE BROWN IRON / GU24

Lampshade 7.09" x 5.91" x 4.72"

- P-103U COTTON
- P-098U WHITE TRANSLUCENT RIBBON
- P-099U CREAM TRANSLUCENT RIBBON

**FERRARA - 2 LUCES**

WALL LAMP



2 x 60 W A-15 E-26

2 x 13 W twist lock GU24 self ballasted lamp

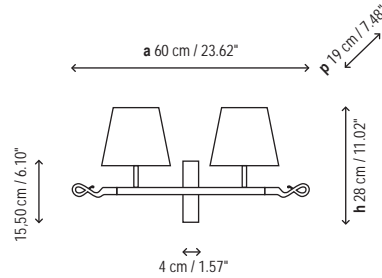

- 1224204U BLACK IRON
- 1224203U GRAPHITE BROWN IRON

- 1224204GU BLACK IRON / GU24
- 1224203GU GRAPHITE BROWN IRON / GU24

Lampshade 7.09" x 5.91" x 4.72"

- P-103U COTTON
- P-098U WHITE TRANSLUCENT RIBBON
- P-099U CREAM TRANSLUCENT RIBBON

**FERRARA - 2 LUCES**

PENDANT LAMP



2 x 100 W A-19 E-26

2 x 18 W twist lock GU24 self ballasted lamp

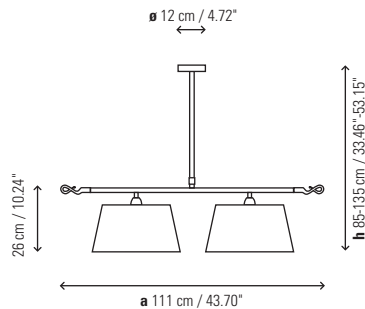

- 4224204U BLACK IRON
- 4224203U GRAPHITE BROWN IRON

- 4224204GU BLACK IRON / GU24
- 4224203GU GRAPHITE BROWN IRON / GU24

Lampshade 14.96" x 7.87" x 11.81"

- P-163CU COTTON
- P-167CU CREAM TRANSLUCENT RIBBON
- P-168CU WHITE TRANSLUCENT RIBBON

The shade includes upper diffuser

**FAMILY**

PAG. 268 268 268 272 272 278 278

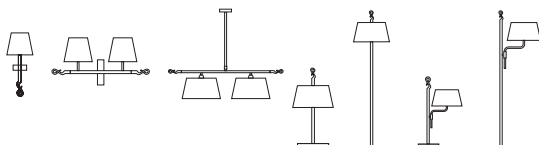

**FINISHING**

BROWN IRON BLACK IRON COTTON CREAM RIBBON WHITE RIBBON





270 > FERRARA - 2 LUCES

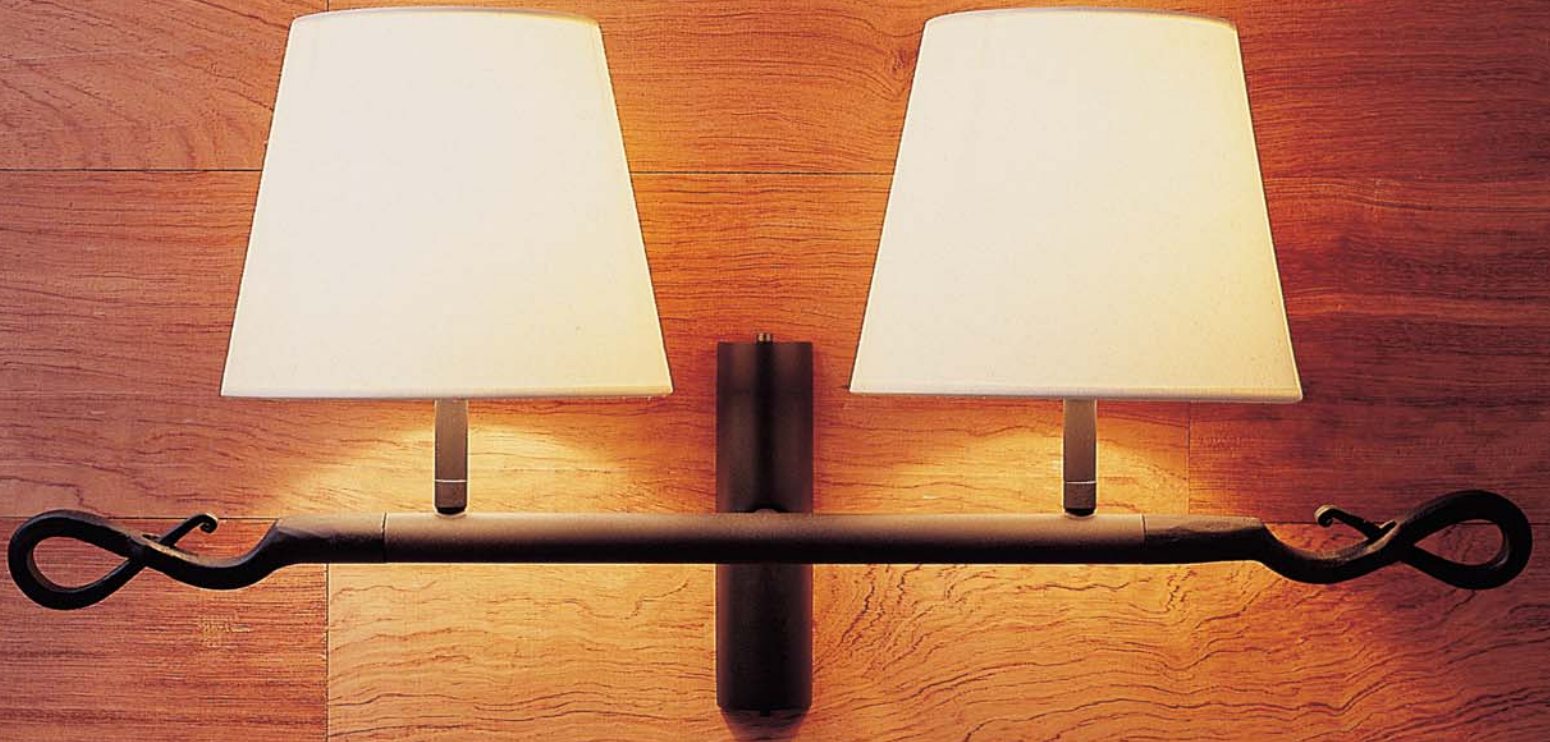





**FERRARA - MESA**

TABLE



2 x 60 W A-15 E-26

2 x 13 W twist lock GU24 self ballasted lamp

∅ 42 cm / 16.54"

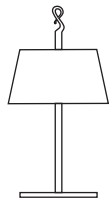

h 72 cm / 28.35"

∅ 30 cm / 11.81"

2224204U *BLACK IRON*  
2224203U *GRAPHITE BROWN IRON*

2224204GU *BLACK IRON / GU24*  
2224203GU *GRAPHITE BROWN IRON / GU24*

Lampshade 16.54" x 9.06" x 12.99"

P-435U *COTTON*  
P-442U *WHITE TRANSLUCENT RIBBON*  
P-443U *CREAM TRANSLUCENT RIBBON*

Shade includes polycarbonate upper diffuser

**FERRARA - PIE**

FLOOR



2 x 60 W A-15 E-26

2 x 13 W twist lock GU24 self ballasted lamp

∅ 42 cm / 16.54"

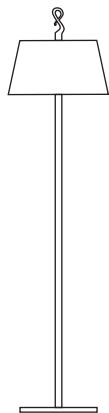

h 188 cm / 66.14"

∅ 30 cm / 11.81"

3024204U *BLACK IRON*  
3024203U *GRAPHITE BROWN IRON*

3024204GU *BLACK IRON / GU24*  
3024203GU *GRAPHITE BROWN IRON / GU24*

Lampshade 16.54" x 9.06" x 12.99"

P-435U *COTTON*  
P-442U *WHITE TRANSLUCENT RIBBON*  
P-443U *CREAM TRANSLUCENT RIBBON*

Shade includes polycarbonate upper diffuser

**FAMILY**

PAG. 270 270 270 272 272 278 278

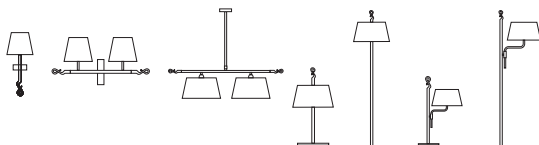

**FINISHING**

BROWN IRON BLACK IRON COTTON CREAM RIBBON WHITE RIBBON









## FERRARA - MESA MÓVIL

DESK LAMP



2 x 60 W A-15 E-26

2 x 13 W twist lock GU24 self ballasted lamp

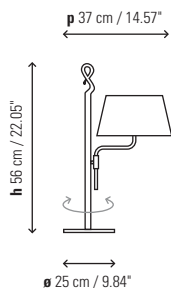

1924204U *BLACK IRON*  
1924203U *GRAPHITE BROWN IRON*

1924204GU *BLACK IRON / GU24*  
1924203GU *GRAPHITE BROWN IRON / GU24*

Lampshade 8.66" x 5.12" x 6.30"

P-409U *COTTON*  
P-407U *WHITE TRANSLUCENT RIBBON*  
P-408U *CREAM TRANSLUCENT RIBBON*

Swivel arm

## FERRARA - PIE MÓVIL

FLOOR



2 x 60 W A-15 E-26

2 x 13 W twist lock GU24 self ballasted lamp

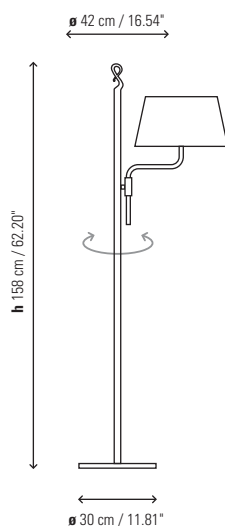

3124204U *BLACK IRON*  
3124203U *GRAPHITE BROWN IRON*

3124204GU *BLACK IRON / GU24*  
3124203GU *GRAPHITE BROWN IRON / GU24*

Lampshade 12.99" x 7.09" x 9.84"

P-148U *WHITE TRANSLUCENT RIBBON*  
P-157U *CREAM TRANSLUCENT RIBBON*  
P-159U *COTTON*

Swivel arm

### FAMILY

PAG. 270 270 270 274 274 278 278

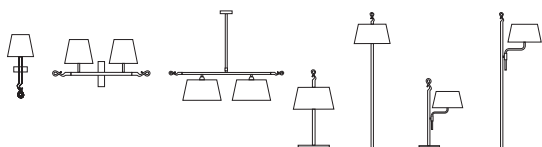

### FINISHING

BROWN IRON BLACK IRON COTTON CREAM RIBBON WHITE RIBBON

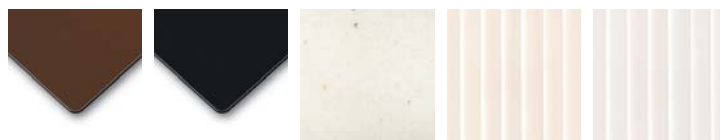









**TOUS - 3 LUCES**  
PENDANT LAMP



3 x 60 W A-15 E-26

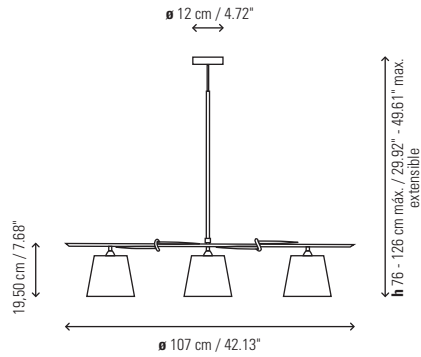

4323404U BLACK IRON  
4323403U GRAPHITE BROWN IRON

Lampshade 7.09" x 5.91" x 4.72"

P-100CU PARCHMENT  
P-103CU COTTON

**TOUS - MESA**  
TABLE



3 x 60 W A-15 E-26

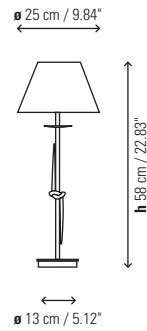

2123404U BLACK IRON  
2123403U GRAPHITE BROWN IRON

Lampshade 9.84" x 6.30" x 4.72"

P-380U PARCHMENT  
P-383U COTTON

**TOUS - PIE**  
FLOOR



1 x 100 W A-19 E-26

1 x 18 W twist lock GU24 self ballasted lamp

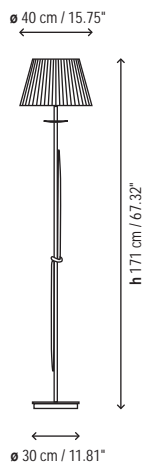

3023404U BLACK IRON  
3023403U GRAPHITE BROWN IRON

3023404GU BLACK IRON / GU24  
3023403GU GRAPHITE BROWN IRON / GU24

Lampshade 15.75" x 10.24" x 9.84"

P-270U PARCHMENT  
P-273U COTTON

**FINISHING**

BROWN IRON      BLACK IRON      PARCHMENT      COTTON

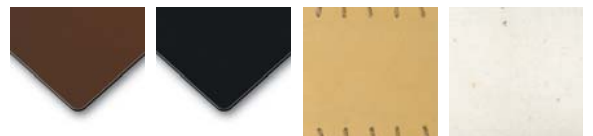





# *TABLE LIGHT*



**PEANA - 01**  
FONDA EUROPA

TABLE LAMP



1 x 100 W A-19 E-26

1 x 20 W T4 E-26  
self ballasted lamp

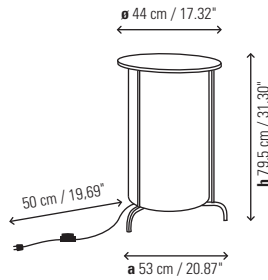

- 0124702U BRASS - WHITE LACQUER
- 0124707U POLISHED BRASS - NATURAL WOOD
- 0124706U POLISHED BRASS - WENGUE WOOD
- 0124701U CHROME - WHITE LACQUER
- 0124705U CHROME - NATURAL WOOD
- 0124704U CHROME - WENGUE WOOD

Lampshade 11.81" x 25.98"

P-519U WHITE COTTON

**PEANA - 02**  
FONDA EUROPA

TABLE LAMP



1 x 100 W A-19 E-26

1 x 20 W T4 E-26  
self ballasted lamp

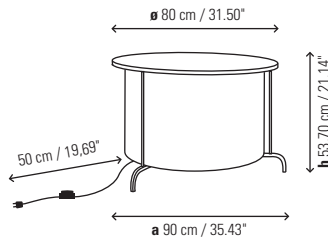

- 0224702U BRASS - WHITE LACQUER
- 0224707U POLISHED BRASS - NATURAL WOOD
- 0224706U POLISHED BRASS - WENGUE WOOD
- 0224701U CHROME - WHITE LACQUER
- 0224705U CHROME - NATURAL WOOD
- 0224704U CHROME - WENGUE WOOD

Lampshade 17.32" x 26.77"

P-540U WHITE COTTON

**PEANA - 03**  
FONDA EUROPA

TABLE LAMP



1 x 100 W A-19 E-26

1 x 20 W T4 E-26  
self ballasted lamp

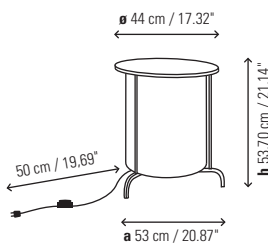

- 0324702U BRASS - WHITE LACQUER
- 0324707U POLISHED BRASS - NATURAL WOOD
- 0324706U POLISHED BRASS - WENGUE WOOD
- 0324701U CHROME - WHITE LACQUER
- 0324705U CHROME - NATURAL WOOD
- 0324704U CHROME - WENGUE WOOD

Lampshade 11.81" x 15.75"

P-543U WHITE COTTON

**FINISHING**

BRASS BRILLIANT CHROME NATURAL WOOD WHITE LACQUER WENGUE COTTON WHITE

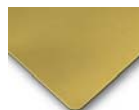











EDITOR / PUBLISHER  
JOANA BOVER

DISSENY GRÀFIC / GRAPHIC DESIGNER  
MIQUEL LLACH

FOTOGRAFIES / PHOTOGRAPHERS  
JORDI SOLÉ / J.E. ESTUDI DISSENY

AGRAÏMENTS / SPECIAL THANKS  
Arkitektura Barcelona  
Mireia Sust / Hoteles Vincci  
Hotel Nord 1901 / Girona  
Danone / Barcelona  
Cinta F. Camps / Hostal Empúries / L'Escala  
Fonda Europa / Granollers  
Hotel Villa Emilia / Barcelona  
Restaurant Pasarela / La Roca Village  
Coquinaria / Santa Agnès de Malanyanes  
Farmàcia Mercè Carbonell / Cardedeu

DIPÒSIT LEGAL: 18084-09

MARÇ 2013

## **BOVER USA**

330 West 38<sup>th</sup> St, Suite 807  
New York, NY 10018

**Tel.:** (347) 767 3413

**e-mail:** [infousa@bover.es](mailto:infousa@bover.es)  
[www.bover.es](http://www.bover.es)

## **HEADQUARTERS OFFICES:**

### **BOVER IL·LUMINACIÓ & MOBILIARI SL BARCELONA**

Avinguda Catalunya, 173  
Pol. Ind. Sud  
08440 Cardedeu  
Barcelona · Spain

**Tels.:** +34 93 871 31 52 / + 34 93 844 47 54  
**Fax:** +34 93 846 20 89  
**e-mail:** [info@bover.es](mailto:info@bover.es)  
**e-mail:** [export@bover.es](mailto:export@bover.es)  
[www.bover.es](http://www.bover.es)